

KRAFTWERK®

FAVORITE TOOLS SINCE 1979

Utensili manuali



Kraftwerk Tools produce utensili manuali di alta qualità per uso professionale ed industriale.

 **HOMBERGER**

www.homberger-utensiliprofessionali.com

MOBILIO – La soluzione perfetta per ogni esigenza!



NUOVA BLACK EDITION

Massima flessibilità per la tua officina, ora anche nel nuovo colore nero elegante!

- Piani di lavoro ultra resistenti in faggio multistrato o in acciaio inox 430
- Estensione MOBILIO DEEP: espandi lo spazio per i tuoi progetti! Piani di lavoro profondi 69 cm!
- Ganci e accessori per un'organizzazione impeccabile
- Inserti portautensili in schiuma EVA: completa il tuo Mobilio con l'attrezzatura

MOBILIO DEEP - Più spazio, più comfort, più efficienza

Con MOBILIO DEEP ampli la profondità del piano di lavoro grazie a un top in faggio maggiorato ed alle console di estensione compatibili con le basi standard.

Per ogni modulo sono necessari due telai di collegamento. Per ogni elemento aggiuntivo, serve solo un telaio extra (es. 2 elementi = 3 telai).



69 cm



Installazione facile
Maggiore superficie operativa
Soluzione modulare ed efficiente

**PIANI DI LAVORO
IN FAGGIO
MULTISTRATO
PROFONDI 69 CM!**

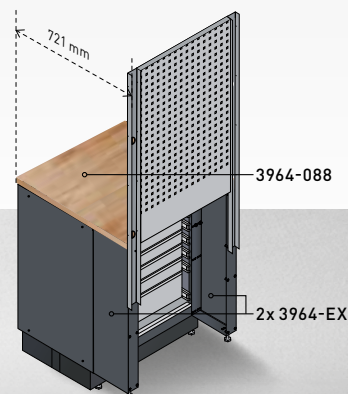
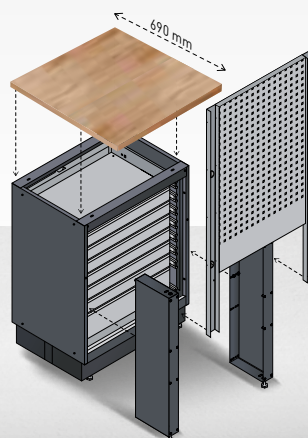

SCOPRI MOBILIO DEEP
La soluzione ideale per una superficie di lavoro più ampia!

SISTEMI DI ARREDAMENTO MODULARE CONFIGURATI

Combinazioni disponibili anche con piani di lavoro profondi / DEEP

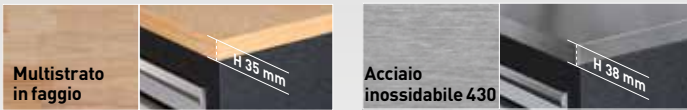

MOBILIO GRIGIO E BLACK EDITION

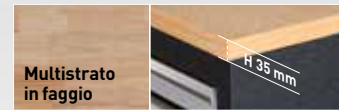

MOBILIO DEEP

Parete da officina MOBILIO a 3 elementi



Colore	Art.	Top	Profondità	Prezzo Listino	Prezzo PROMO
Black	3964A-BLK	Standard	463 mm	€ 2.579,00	€ 1.550,00
Black	3964A-BLK-EX	DEEP	690 mm	€ 2.919,00	€ 1.690,00
Black	3964A-BLK-IX	Standard	463 mm	€ 2.729,00	€ 1.550,00
Grey	3964A	Standard	463 mm	€ 2.579,00	€ 1.550,00
Grey	3964A-EX	DEEP	690 mm	€ 2.919,00	€ 1.690,00
Grey	3964AIX	Standard	463 mm	€ 2.729,00	€ 1.550,00

+ A 2000 x L 1960 x P 488 mm

+ A 2000 x L 1960 x P 721 mm - DEEP

Parete da officina MOBILIO a 4 elementi



Colore	Art.	Top	Profondità	Prezzo Listino	Prezzo PROMO
Black	3964B-BLK	Standard	463 mm	€ 3.539,00	€ 2.150,00
Black	3964B-BLK-EX	DEEP	690 mm	€ 4.009,00	€ 2.450,00
Black	3964B-BLK-IX	Standard	463 mm	€ 3.679,00	€ 2.150,00
Grey	3964B	Standard	463 mm	€ 3.539,00	€ 2.150,00
Grey	3964B-EX	DEEP	690 mm	€ 4.009,00	€ 2.450,00
Grey	3964BIX	Standard	463 mm	€ 3.679,00	€ 2.150,00

+ A 2000 x L 2640 x P 488 mm

+ A 2000 x L 2640 x P 721 mm - DEEP

Parete da officina MOBILIO a 4 elementi



Disponibile
anche in grigio

Colore	Art.	Top	Profondità	Prezzo Listino	Prezzo PROMO
■	3964D-BLK		463 mm	€ 4.029,00	€ 2.500,00
■	3964D-BLK-EX	DEEP	690 mm	€ 4.459,00	€ 2.790,00
■	3964D-BLK-IX		463 mm	€ 4.159,00	€ 2.500,00
■	3964D		463 mm	€ 4.029,00	€ 2.500,00
■	3964D-EX	DEEP	690 mm	€ 4.459,00	€ 2.790,00
■	3964DIX		463 mm	€ 4.159,00	€ 2.500,00

+ A 2000 × L 2955 × P 488 mm

+ A 2000 × L 2955 × P 721 mm - **DEEP**

Parete da officina MOBILIO a 4 elementi



Disponibile
anche in grigio

Colore	Art.	Top	Profondità	Prezzo Listino	Prezzo PROMO
■	3964G-BLK		463 mm	€ 3.679,00	€ 2.350,00
■	3964G-BLK-EX	DEEP	690 mm	€ 4.119,00	€ 2.690,00
■	3964G-BLK-IX		463 mm	€ 3.789,00	€ 2.350,00
■	3964G		463 mm	€ 3.679,00	€ 2.350,00
■	3964G-EX	DEEP	690 mm	€ 4.119,00	€ 2.690,00
■	3964GIX		463 mm	€ 3.789,00	€ 2.350,00

+ A 2000 × L 2955 × P 488 mm

+ A 2000 × L 2955 × P 721 mm - **DEEP**

Parete da officina MOBILIO a 6 elementi



Disponibile
anche in grigio

Colore	Art.	Top	Profondità	Prezzo Listino	Prezzo PROMO
■	3964C-BLK		463 mm	€ 5.319,00	€ 2.990,00
■	3964C-BLK-EX	DEEP	690 mm	€ 5.969,00	€ 3.570,00
■	3964C-BLK-IX		463 mm	€ 5.569,00	€ 3.100,00
■	3964C		463 mm	€ 5.319,00	€ 2.990,00
■	3964C-EX	DEEP	690 mm	€ 5.969,00	€ 3.570,00
■	3964CIX		463 mm	€ 5.569,00	€ 3.100,00

+ A 2000 × L 3920 × P 488 mm

+ A 2000 × L 3920 × P 721 mm - **DEEP**

Parete da officina MOBILIO a 6 elementi



Disponibile
anche in grigio

Colore	Art.	Top	Profondità	Prezzo Listino	Prezzo PROMO
Black	3964K-BLK-017	Orange	463 mm	€ 6.259,00	€ 3.350,00
Black	3964K-BLK-017-EX	DEEP	690 mm	€ 6.619,00	€ 3.650,00
Black	3964K-BLK-017-IX	Grey	463 mm	€ 6.419,00	€ 3.350,00
Grey	3964K-HS745H-K4	Orange	463 mm	€ 6.259,00	€ 3.350,00
Grey	3964K-HS745H-K4-EX	DEEP	690 mm	€ 6.619,00	€ 3.650,00
Grey	3964K-HS745H-K4IX	Grey	463 mm	€ 6.419,00	€ 3.350,00

+ A 2000 x L 3920 x P 488 mm

+ A 2000 x L 3920 x P 721 mm - DEEP

Parete da officina MOBILIO a 5 elementi



Disponibile
anche in grigio

Colore	Art.	Top	Profondità	Prezzo Listino	Prezzo PROMO
Black	3964H-BLK	Orange	463 mm	€ 4.199,00	€ 2.790,00
Black	3964H-BLK-IX	Grey	463 mm	€ 4.269,00	€ 2.890,00
Grey	3964H	Orange	463 mm	€ 4.199,00	€ 2.790,00
Grey	3964HIX	Grey	463 mm	€ 4.269,00	€ 2.890,00

+ A 2000 x L 3635 x P 488 mm

Parete da officina MOBILIO a 3 elementi



Disponibile
anche in grigio

Colore	Art.	Top	Profondità	Prezzo Listino	Prezzo PROMO
Black	3964R-BLK	Orange	463 mm	€ 3.029,00	€ 2.050,00
Black	3964R-BLK-IX	Grey	463 mm	€ 3.209,00	€ 2.050,00
Grey	3964R	Orange	463 mm	€ 3.029,00	€ 2.050,00
Grey	3964RIX	Grey	463 mm	€ 3.209,00	€ 2.050,00

+ A 2000 x L1 1574 x L2 1574 x P 488 mm

Parete da officina MOBILIO a 2 elementi



Colore	Art.	Top	Profondità	Prezzo Listino	Prezzo PROMO
■	3964K-BLK-021		463 mm	€ 3.169,00	€ 1.750,00
■	3964K-BLK-021-IX		463 mm	€ 3.249,00	€ 1.750,00
■	3964K-H1W2-K2		463 mm	€ 3.169,00	€ 1.750,00
■	3964K-H1W2-K2IX		463 mm	€ 3.249,00	€ 1.750,00

+ A 2000 × L 1960 × P 488 mm



Parete da officina MOBILIO a 2 elementi



Colore	Art.	Top	Profondità	Prezzo Listino	Prezzo PROMO
■	3964K-BLK-022		463 mm	€ 3.259,00	€ 1.890,00
■	3964K-BLK-022-IX		463 mm	€ 3.299,00	€ 1.890,00
■	3964K-H2W1-K1		463 mm	€ 3.259,00	€ 1.890,00
■	3964K-H2W1-K1IX		463 mm	€ 3.299,00	€ 1.890,00

+ A 2000 × L 2275 × P 488 mm



Parete da officina MOBILIO a 3 elementi



Colore	Art.	Top	Profondità	Prezzo Listino	Prezzo PROMO
■	3964K-BLK-005		463 mm	€ 3.369,00	€ 1.780,00
■	3964K-BLK-005-IX		463 mm	€ 3.479,00	€ 1.780,00
■	3964K-855-K3		463 mm	€ 3.369,00	€ 1.780,00
■	3964K-855-K3IX		463 mm	€ 3.479,00	€ 1.780,00

+ A 2000 × L 2040 × P 488 mm

Parete da officina MOBILIO a 8 elementi



Disponibile
anche in grigio

Colore	Art.	Top	Profondità	Prezzo Listino	Prezzo PROMO
Black	3964E-BLK	Orange	463 mm	€ 7.999,00	€ 4.990,00
Black	3964E-BLK-IX	Grey	463 mm	€ 8.219,00	€ 4.990,00
Grey	3964E	Orange	463 mm	€ 7.999,00	€ 4.990,00
Grey	3964EIX	Grey	463 mm	€ 8.219,00	€ 4.990,00

+ A 2000 x L1 3819 x L2 2824 x P 488 mm

Rendi perfetta la tua officina: arreda con Mobilio e completa con gli utensili professionali Kraftwerk. Scopri tutto sul nostro catalogo!



https://www.kraftwerk.it/documents/General_Collection_2024_IT.pdf



Contenitori per uso generale

5 pezzi

Art.	Dimensioni	Δ	Prezzo Listino	Prezzo PROMO
198.005.102	A 90 x L 75 x P 50 mm	30 g / 1 pz.	€ 29,00	€ 13,50



Art.	Descrizione	Prezzo Listino	Prezzo PROMO
1 145.126.060	Supporto per trapano Ø 60 mm	€ 15,50	€ 5,30
2 145.126.080	Supporto per trapano Ø 80 mm	€ 10,00	€ 6,00
3 145.129.227	Supporto per 10 chiavi	€ 25,00	€ 15,00
4 145.129.390	Supporto per 12 cacciaviti	€ 15,00	€ 10,50
5 145.130.200	Supporto per 14 punte da trapano	€ 11,00	€ 7,50
6 145.130.390	Supporto per 28 punte da trapano	€ 21,00	€ 14,50



Ripiano per lattine

Pratica soluzione di stoccaggio da appendere alla parete perforata.

Art.	Dimensioni	Δ	Prezzo Listino	Prezzo PROMO
3964-29-01	A 100 x L 330 x P 100 mm	710 g	€ 27,80	€ 23,00



Scatole di plastica blu e ripiano

Scatole di plastica blu disponibili in 3 dimensioni (Ripiano 3964-29-11 **1** è necessario per il montaggio)

Art.	Dimensioni	Δ	Prezzo Listino	Prezzo PROMO
1 3964-29-11	A 54 x L 440 x P 15.5 mm	310 g	€ 6,20	€ 4,50
2 3964-29-14	A 75 x L 105 x P 140 mm	50 g	€ 7,00	€ 5,50
3 3964-29-15	A 125 x L 140 x P 220 mm	150 g	€ 17,50	€ 13,50
4 3964-29-16	A 125 x L 140 x P 270 mm	200 g	€ 18,30	€ 14,90

Set di supporti, 22 pezzi

3 x Art. 145.111.035, L = 35 mm
 4 x Art. 145.111.070, L = 70 mm
 3 x Art. 145.111.135, L = 135 mm
 2 x Art. 145.112.035, L = 35 mm
 2 x Art. 145.112.075, L = 75 mm
 2 x Art. 145.112.150, L = 150 mm
 2 x Art. 145.125.055, L = 55 mm
 1 x Art. 145.126.060, Ø = 60 mm
 1 x Art. 145.129.390, per 12 giraviti
 1 x Art. 145.129.227, per 10 chiavi
 1 x Art. 145.130.200, per 14 punte da trapano



Art.	Δ g	Prezzo Listino	Prezzo PROMO
145.100.900	2270	€ 81,00	€ 64,00



Art.	Descrizione	Prezzo Listino	Prezzo PROMO
1 145.111.035	Gancio 35 mm	€ 3,70	€ 2,50
2 145.111.070	Gancio 87 mm	€ 3,70	€ 2,90
3 145.111.135	Gancio 150 mm	€ 4,90	€ 3,90
4 145.112.035	Gancio doppio 35 mm	€ 5,00	€ 3,50
5 145.112.050	Gancio doppio 87 mm	€ 5,00	€ 3,50
6 145.112.075	Gancio doppio 150 mm	€ 5,00	€ 3,60

Porta rotolo

Adatto per installazione su pareti forate o carrelli forati
 Diametro tubo = 20 mm
 Adatto a rotoli di carta fino a diametro 300 mm



Art.	Dimensioni	Δ	Prezzo Listino	Prezzo PROMO
145.143.010	A 150 x L 300 x P 220 mm	1,6 kg	€ 67,00	€ 52,00

Vano porta oggetti

Adatto per installazione su pareti forate o carrelli forati



Art.	Dimensioni	Δ	Prezzo Listino	Prezzo PROMO
145.143.011	A 60 x L 215 x P 90 mm	500 g	€ 18,90	€ 15,00

Vano portaoggetti con maniglia a 8 scomparti

Adatto per installazione su pareti forate o carrelli forati
 Con pratica maniglia
 Con divisori per 8 bombolette



Art.	Dimensioni	Δ	Prezzo Listino	Prezzo PROMO
145.143.012	A 60 x L 300 x P 90 mm	2,5 kg	€ 115,00	€ 89,00

Cestino

Adatto per installazione su pareti forate o carrelli forati



Art.	Dimensioni	Δ	Prezzo Listino	Prezzo PROMO
145.143.013	A 300 x L 300 x P 160 mm	3,5 kg	€ 63,00	€ 49,00

VASCHEE PER CASSETTI



Misure vaschette
 No. 1 rossa: 45x54x54 mm
 No. 2 gialla: 45x108x54 mm
 No. 3 blu: 45x108x108 mm
 No. 4 grigio: 45x108x216 mm

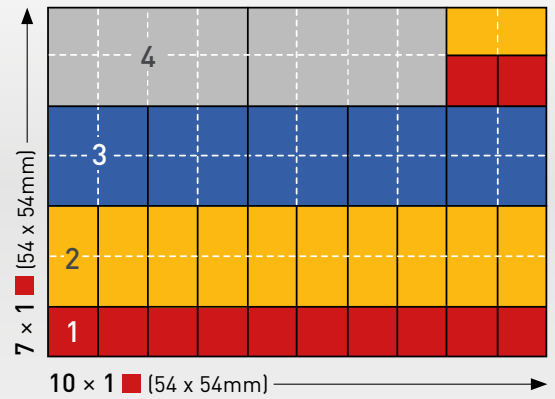

Art. 198.001.001

Set di vaschette, 30 pezzi

Disposizione ideale per un cassetto
 - 12x vaschette No. 1, rosse
 - 11x vaschette No. 2, gialle
 - 5x vaschette No. 3, blu
 - 2x vaschette No. 4, grigie

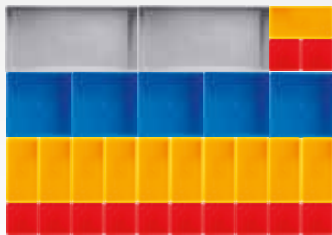

LISTINO ~~€ 42,40~~
€ 29,00



Art. 198.001.002

Set di vaschette, 21 pezzi

Disposizione ideale per un cassetto
 - 6x vaschette No. 1, rosse
 - 6x vaschette No. 2, gialle
 - 5x vaschette No. 3, blu
 - 4x vaschette No. 4, grigie



LISTINO ~~€ 36,10~~
€ 26,00

Art. 198.001.003

Set di vaschette, 23 pezzi

Disposizione ideale per un cassetto
 - 12x vaschette No. 1, rosse
 - 3x vaschette No. 2, gialle
 - 3x vaschette No. 3, blu
 - 5x vaschette No. 4, grigie

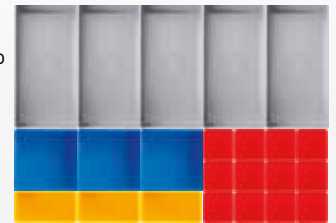

LISTINO ~~€ 36,10~~
€ 26,00

Art. 198.001.004

Set di vaschette, 22 pezzi

Disposizione ideale per un cassetto
 - 4x vaschette No. 1, rosse
 - 5x vaschette No. 2, gialle
 - 12x vaschette No. 3, blu
 - 1x vaschette No. 4, grigie

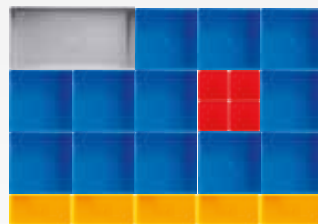

LISTINO ~~€ 36,10~~
€ 26,00

Art. 198.001.005

Set di vaschette, 26 pezzi

Disposizione ideale per un cassetto
 - 4x vaschette No. 1, rosse
 - 15x vaschette No. 2, gialle
 - 5x vaschette No. 3, blu
 - 2x vaschette No. 4, grigie

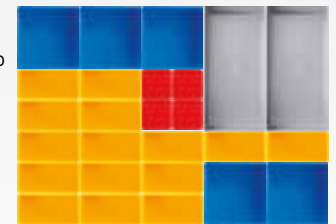

LISTINO ~~€ 36,10~~
€ 26,00

Lampada a LED sottopensile

- Le luci sono dotate di magneti e alette di fissaggio, quindi possono essere posizionate ovunque
- Entrambe le luci possono anche essere collegate in serie
- Cavo principale da 5 m, cavo di connessione 35 cm

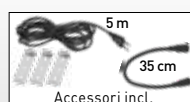

Art. n°	Misure / Peso	Listino	Promo
32077-60	590 x 124 x 43 mm / 1,2 Kg	€ 148,00	€ 118,00
32077-120	1200 x 124 x 43 mm / 2,3 Kg	€ 229,00	€ 171,00

MOBILIO BLACK

Arreda la tua officina!

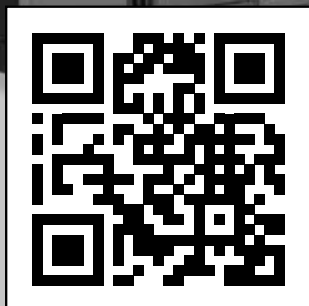

**VISITA IL SITO
E SCOPRI IL CONFIGURATORE**

mobilio-configurator.kraftwerktools.com

Semplice! Solo 4 passaggi:

Passo 1 Scegli dimensione e modelli

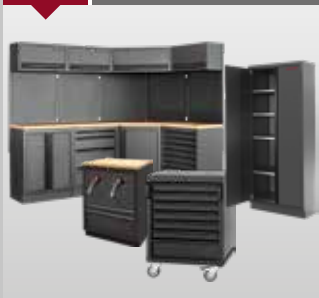

Passo 2 Scegli i tuoi utensili professionali

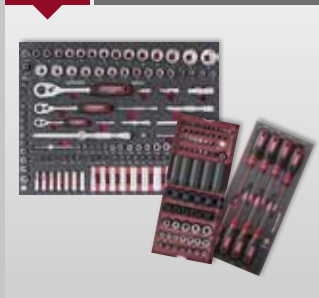

Passo 3 Scegli gli accessori



Passo 4 La tua officina MOBILIO personalizzata





CARRELLI
PORTAUTENSILI

KRAFTWERK®
FAVORITE TOOLS SINCE 1979

PT LINE
BT LINE
LT LINE

 **MADE IN GERMANY**

CARRELLO DA OFFICINA **LT700**

SPECIAL EDITION



Chiusura centralizzata di tutti i cassetti su un lato con serratura a cilindro



Cassetti piú grandi e stabili
Cassetti rinforzati e guide per cassetti ad estrazione totale



2 ruote girevoli con freno,
2 ruote rigide
Ruota in gomma termoplastica, cerchio in plastica



MADE IN GERMANY



Art. 101.106.BLK	L1	L2	L3	Δ
	719 mm	474 mm	1000 mm	450 kg
L4	600 mm	400 mm	75 mm	45 kg
L5	600 mm	400 mm	150 mm	45 kg





SPECIAL EDITION



Art. 101.106.BLK	L1	L2	L3	Δ
	719 mm	474 mm	1000 mm	450 kg
	L4	400 mm	75 mm	45 kg
	L5	400 mm	150 mm	45 kg



Art. 102.106.BLK

Carrello da officina LT700 a 6 cassetti, attrezzato, 339 pezzi

- MADE IN GERMANY
- Piano di lavoro in ABS è resistente agli agenti chimici
- Struttura a doppia parete robusta
- Cassetti su guide a cuscinetto
- Gli utensili sono riposti in 4 vassoi in schiuma ad alta densità (EVA) 60 x 40 cm
- Chiavi combinate da 6 a 22 mm
- Chiavi a cricchetto da 1/4" + 1/2"
- Chiavi a bussola da 1/4" da 4 a 14 mm
- Chiavi a bussola da 1/2" da 10 a 32 mm

LISTINO € 1.373,00
€ 855,00



CARRELLO VUOTO

Carrello da officina LT700 a 6 cassetti, vuoto

Art.	↑ mm	↔ mm	↔ mm	↘ mm	Kg		↓ mm	400 x 600 mm	Kg	Δ kg	Listino	PROMO
101.106.BLK	1000	799	719	474	450	6	3 x 150 mm; 3 x 75 mm		45	57	€ 669,00	€ 449,00

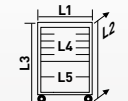

Art. 101.106.BLK	L1	L2	L3	Δ
	719 mm	474 mm	1000 mm	450 kg
	L4	400 mm	75 mm	45 kg
	L5	400 mm	150 mm	45 kg



Art. 102.106.HOM





Carrello da officina LT700 a 6 cassetti, attrezzato, 339 pezzi

- MADE IN GERMANY
- Piano di lavoro in ABS è resistente agli agenti chimici
- Struttura a doppia parete robusta
- Cassetti su guide a cuscinetto
- Gli utensili sono riposti in 4 vassoi in schiuma ad alta densità (EVA) 60 x 40 cm
- Chiavi combinate da 6 a 22 mm
- Chiavi a cricchetto da 1/4" + 1/2"
- Chiavi a bussola da 1/4" da 4 a 14 mm
- Chiavi a bussola da 1/2" da 10 a 32 mm

LISTINO € 1.373,00
€ 855,00



Carrello da officina LT700 a 6 cassetti, vuoto

Art.	↑ mm	↔ mm	↔ mm	↗ mm	 Kg		 ↓ mm 	400 × 600 mm	 Kg	Δ kg	Listino	PROMO
101.106.HOM	1000	799	719	474	450	6	3 × 150 mm; 3 × 75 mm		45	57	€ 669,00	€ 449,00



Art. 101.107.HOM	L1	L2	L3	Δ
	719 mm	474 mm	1000 mm	450 kg
	L4	400 mm	75 mm	45 kg
	L5	400 mm	150 mm	45 kg

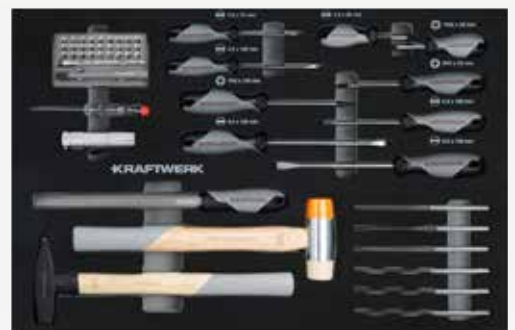
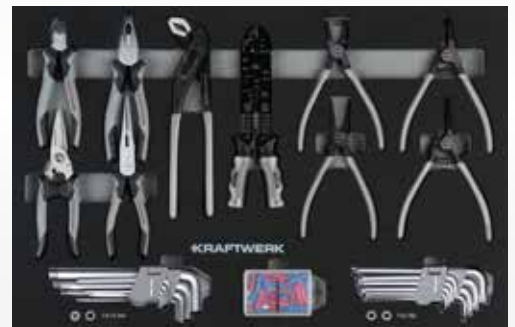
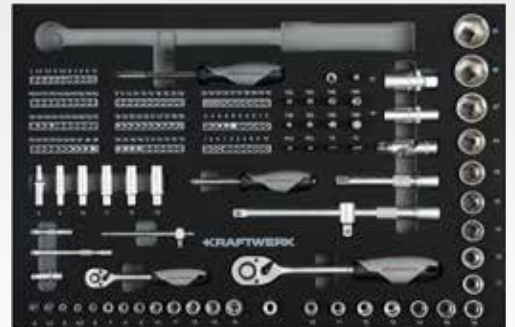

Art. 102.107.HOM

Carrello da officina LT700 a 7 cassetti, attrezzato, 339 pezzi

- MADE IN GERMANY
- Piano di lavoro in ABS è resistente agli agenti chimici
- Struttura a doppia parete robusta
- Cassetti su guide a cuscinetto
- Gli utensili sono riposti in 4 vassoi in schiuma ad alta densità (EVA) 60 x 40 cm
- Chiavi combinate da 6 a 22 mm
- Chiavi a cricchetto da 1/4" + 1/2"
- Chiavi a bussola da 1/4" da 4 a 14 mm
- Chiavi a bussola da 1/2" da 10 a 32 mm

LISTINO € 1.403,00
€ 890,00



Carrello da officina LT700 a 7 cassetti, vuoto

Art.	↑ mm	↔ mm	↔ mm	↘ mm				400 x 600 mm		Δ kg	Listino	PROMO
101.107.HOM	1000	799	719	474	450	7	2 x 150 mm; 5 x 75 mm		45	59	€ 699,00	€ 469,00

Art. 102.107.203

Carrello da officina LT700 a 7 cassetti, attrezzato, 339 pezzi

- MADE IN GERMANY
- Piano di lavoro in ABS è resistente agli agenti chimici
- Struttura a doppia parete robusta
- Cassetti su guide a cuscinetto
- Gli utensili sono riposti in 4 vassoi in schiuma ad alta densità (EVA) 60 x 40 cm
- Chiavi combinate da 6 a 22 mm
- Chiavi a cricchetto da 1/4" + 1/2"
- Chiavi a bussola da 1/4" da 4 a 14 mm
- Chiavi a bussola da 1/2" da 10 a 32 mm



MADE IN GERMANY



LISTINO ~~€ 1.299,00~~
€ 890,00

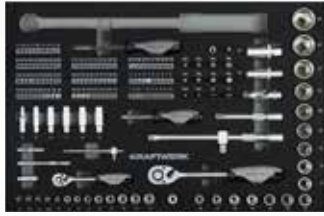

Art. 102.107.204

Carrello da officina LT700 a 7 cassetti, attrezzato, 301 pezzi

- MADE IN GERMANY
- Piano di lavoro in ABS è resistente agli agenti chimici
- Struttura a doppia parete robusta
- 7 cassetti su guide a cuscinetto
- Gli utensili sono riposti in 6 vassoi in schiuma ad alta densità (EVA) 60 x 40 cm
- Chiavi combinate da 5.5 a 24 mm
- Chiavi a cricchetto 1/4"+3/8"+1/2"
- Chiavi a bussola 1/4" da 4 a 14 mm
- Chiavi a bussola 3/8" da 10 a 24 mm
- Chiavi a bussola 1/2" da 14 a 32 mm

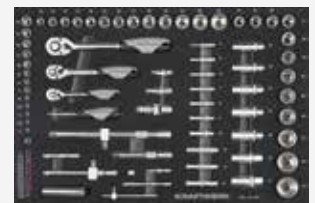

MADE IN GERMANY



LISTINO ~~€ 1.739,00~~
€ 1.380,00



Art. 101.107.200	L1	L2	L3	ΔΔ
	719 mm	474 mm	1000 mm	450 kg
L4	600 mm	400 mm	75 mm	45 kg
L5	600 mm	400 mm	150 mm	45 kg



Carrello da officina LT700 a 7 cassetti, vuoto

Art.	↑ mm	↔ mm	↔ mm	↗ mm	Kg		mm	mm	Kg	ΔΔ kg	Listino	PROMO
101.107.200	1000	799	719	474	450	7	2 x 150 mm; 5 x 75 mm	45	57		€ 699,00	€ 469,00

Art. 101.103.200

Carrello per carrozzieri LT700 con 3 cassetti, VUOTO

- MADE IN GERMANY
- Copertura in PS resistente agli agenti chimici
- 3 cassetti con guide su cuscinetti a sfera ad estrazione totale
- Chiusura centralizzata di tutti i cassetti su un lato con serratura a cilindro
- 2 ruote girevoli con freno, 2 ruote fisse
- Capacità di carico per cassetto 45 kg
- Capacità di carico totale 450 kg
- Può essere equipaggiato con diversi vassoi Kraftwerk 400 x 600 mm dimensione interna
- Fornito senza utensili e accessori
- Cassetti 2 x 75 mm / 1 x 150 mm



LISTINO ~~€ 615,00~~
€ 499,00



Compatibile con vassoi in schiuma ad alta densità EVA

Made in Germany



Art. 101.103.200	L1	L2	L3	SD
	719 mm	474 mm	1000 mm	450 kg
L4	600 mm	400 mm	75 mm	45 kg
L5	600 mm	400 mm	150 mm	45 kg
L6	630 mm	465 mm	455 mm	45 kg

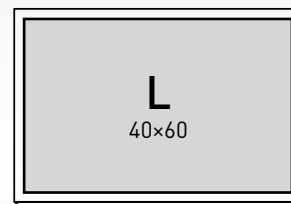
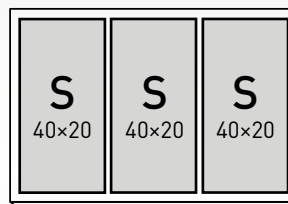

Art. 102.103.201

LT LINE Carrello per carrozzieri LT700, 3 cassetti, 121 pz.

- MADE IN GERMANY
- 121 utensili di alta qualità con 7 vassoi in EVA
- Set di chiavi a bussola da 1/4"
- Set di chiavi a bussola da 1/2"
- Set di chiavi ad anello/open-end 8-19 mm
- Set di cacciaviti a taglio PRO LINE 4 - 8 mm + PH 1 e 2
- Set di utensili a percussione
- Set di pinze HIGHTECH
- Pinza universale 180mm, tronchese laterale, 160 mm, pinza a becchi mezzotondi 205 mm, pinza regolabile 240 mm
- Martello da fabbro, mazzuola in nylon, scalpello piatto 18-22 mm, cacciapine 2-8 mm
- Lima per carrozzeria radiale a 9, 12, 15 denti
- Supporto per lima da carrozzeria
- Scalpello da carrozzeria
- Scalpello per carrozzeria
- Martelli specifici per carrozzieri



PRO LINE



LISTINO ~~€ 1.899,00~~
€ 1.469,00

CARRELLO DA OFFICINA **BT700**



Pareti laterali rettangolari forate
Facile fissaggio degli accessori.

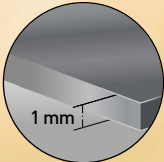

Struttura
Struttura a doppia parete molto robusta.



2 ruote girevoli con freno, 2 ruote rigide
Ruota in gomma termoplastica, cerchio in plastica.

Chiusura centralizzata di tutti i cassetti su un lato con serratura a cilindro.



Antiribaltamento
Cassetti con antiribaltamento (si apre un solo cassetto alla volta).

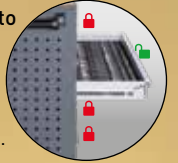

Cassetti più grandi e stabili
Cassetti rinforzati e guide per cassetti ad estrazione totale.

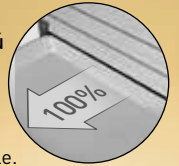

MADE IN GERMANY

Art. 101.118.100	L1	L2	L3	ΔTΔ
	719 mm	474 mm	1000 mm	450 kg
L4	600 mm	400 mm	75 mm	45 kg
L5	600 mm	400 mm	150 mm	45 kg



Cassettiere per carrelli da officina BT700/BT900, vuote

MADE IN GERMANY

Per tutti i carrelli BT LINE 60/40 cm e 80/40 cm

Struttura robusta a doppia parete

Cassetti su guide a cuscinetto

Serratura di blocco laterale di tutti i cassetti

Portata per cassetto 45 kg

MADE IN GERMANY

Art. 101.900.002

1369 x 720 x 474 mm | 27.02 kg

	mm	mm	mm
1x	75	600	400
1x	150	600	400

max. 420 kg



LISTINO ~~€ 490,00~~
€ 399,00



Art. 101.900.003

1369 x 720 x 474 mm | 30.06 kg

	mm	mm	mm
3x	75	600	400

max. 420 kg



LISTINO ~~€ 619,00~~
€ 505,00

Art. 102.117.103

Carrello da officina BT700 a 7 cassetti, attrezzato, 339 pezzi

- MADE IN GERMANY
- Piano di lavoro in ABS è resistente agli agenti chimici
- Con pareti laterali forate
- Struttura a doppia parete robusta
- 7 cassetti su guide a cuscinetto
- Gli utensili sono riposti in 4 vassoi in schiuma ad alta densità (EVA) 60 x 40 cm
- Chiavi combinate da 6 a 22 mm
- Chiavi a cricchetto 1/4" + 1/2"
- Chiavi a bussola 1/4" da 4 a 14 mm
- Chiavi a bussola 1/2" da 10 a 32 mm
- Spazio per art. 3235 chiave dinamometrica 1/2", 40-200 Nm (non inclusa)



MADE IN GERMANY



LISTINO € 1.574,00
€ 1.090,00

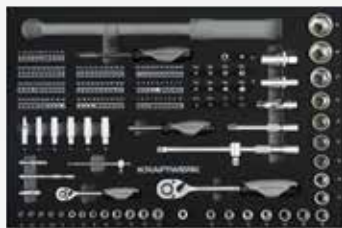

Art. 102.117.104

Carrello da officina BT700 a 7 cassetti, attrezzato, 301 pezzi

- MADE IN GERMANY
- Piano di lavoro in ABS è resistente agli agenti chimici
- Con pareti laterali forate
- Struttura a doppia parete robusta
- 7 cassetti su guide a cuscinetto
- Gli utensili sono riposti in 6 vassoi in schiuma ad alta densità (EVA)
- Chiavi combinate da 5.5 a 24 mm
- Chiavi a cricchetto 1/4"+3/8"+1/2"
- Chiavi a bussola 1/4" da 4 a 14 mm
- Chiavi a bussola 3/8" da 10 a 24 mm
- Chiavi a bussola 1/2" da 14 a 32 mm

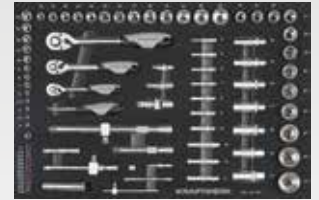

MADE IN GERMANY



LISTINO € 1.987,00
€ 1.540,00



Art. 101.117.100	L1	L2	L3	ΔΣ	
	719 mm	474 mm	1000 mm	450 kg	
	L4	600 mm	400 mm	75 mm	45 kg
	L5	600 mm	400 mm	150 mm	45 kg



Carrello da officina BT700 a 7 cassetti, vuoto

Art.	↑ mm	↔ mm	↔ mm	↗ mm			↳ mm	↳ mm		ΔΣ kg	Listino	PROMO
101.117.100	1000	799	719	474	450	7	2 x 150 mm; 5 x 75 mm	45	57		€ 1.020,00	€ 640,00

Art. 102.117.430

Carrello da officina BT700 a 7 cassetti, equipaggiato con utensili VDE, 103 pezzi

- MADE IN GERMANY
- Gli utensili sono riposti in 5 vassoi in schiuma ad alta densità (EVA) 60 x 40 cm
- Set di segnali di avvertimento e sicurezza ad alta tensione
- Giravite VDE a taglio 2,5 - 8 mm
- Giravite VDE PH PH0 - PH3
- Giravite VDE PZ PZ0 - PZ3
- Giravite VDE tamper TX T6 - T45
- Giravite VDE esagonale 2,5 - 8 mm
- Tester di tensione
- Pinze VDE
- Cricchetto 3/8" VDE
- Bussole VDE 3/8" 8 - 22 mm
- VDE chiave esagonale con impugnatura a T 4 - 14 mm
- Chiavi a forchetta VDE 8 - 19 mm

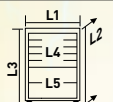

LISTINO € 2.979,00
€ 1.890,00

Art. 101.117.101	L1	L2	L3	ΔTD
	719 mm	474 mm	1000 mm	450 kg
L4	600 mm	400 mm	75 mm	45 kg
L5	600 mm	400 mm	150 mm	45 kg



Art. 102.117.431

Carrello da officina BT700 a 7 cassetti, equipaggiato con utensili VDE, 111 pezzi

- MADE IN GERMANY
- Gli utensili sono riposti in 5 vassoi in schiuma ad alta densità (EVA) 60 x 40 cm
- Set di segnali di avvertimento e sicurezza ad alta tensione
- Giravite VDE a taglio: 2,5 - 8 mm
- Giravite VDE PH: PH0 - PH3
- Giravite VDE PZ: PZ0 - PZ3
- Giravite VDE tamper TX: T6 - T45
- Giravite VDE esagonale: 2,5 - 8 mm
- Tester di tensione
- Pinze VDE
- Cricchetto 3/8" VDE
- Bussole VDE 3/8": 8 - 22 mm
- VDE chiave esagonale con impugnatura a T: 4 - 14 mm
- Chiavi a forchetta VDE: 8 - 19 mm
- Cintura di sicurezza
- Barriera

LISTINO € 3.389,00
€ 2.350,00

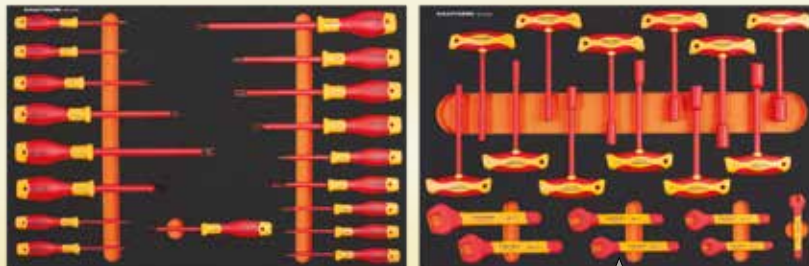



2 ruote girevoli con freno, 2 ruote rigide
Ruota in gomma termoplastica, cerchio in plastica



Vano con ripiano,
capacità di carico 25 kg

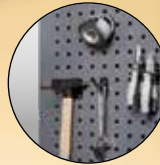

Pareti laterali rettangolari forate
Facile fissaggio degli accessori

Chiusura centralizzata di tutti i cassetti su un lato
con serratura a cilindro



Antiribaltamento
Cassetti con antiribaltamento (si apre un solo cassetto alla volta)

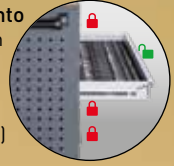

Cassetti più grandi e stabili
Cassetti rinforzati e guide per cassetti ad estrazione totale

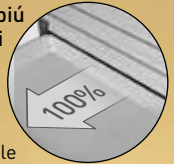

Struttura
Struttura a doppia parete molto robusta

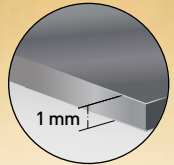

Art. 101.401.000	L1	L2	L3	ΔTA	
	1805 mm	474 mm	1000 mm	450 kg	
	L4	600 mm	400 mm	75 mm	45 kg
	L5	600 mm	400 mm	150 mm	45 kg
	L6	600 mm	400 mm	240 mm	45 kg
	L7	365 mm	465 mm	720 mm	45 kg



Art. 101.401.001

Carrello da officina Basic Line EXTRA LARGO, attrezzato, 377 pezzi

- Gli utensili sono riposti i 9 vassoi in schiuma ad alta intensità (EVA)
- Assortimento di chiavi a bussola 1/4"+3/8"+1/2", 86 pezzi
- Assortimento di chiavi combinate/poligonali doppie curvate, 46 pezzi
- Assortimento di chiavi a bussola 1/4"+3/8"+1/2", 107 pezzi
- Assortimento di giraviti, 22 pezzi
- Assortimento di pinze/strumenti di misura, 13 pezzi
- Assortimento di chiavi a bussola esagonali e Torx, RIBE 90 mm, 30 pezzi
- Assortimento di chiavi a bussola esagonali 1/2" RIBE 100 mm, 21 pezzi
- Assortimento di chiavi a bussola a macchina lunghe, 1/2", 20 pezzi
- Assortimento di martelli, 3 pezzi
- Assortimento di strumenti di smontaggio, 8 pezzi
- Assortimento di giraviti a percussione, 4 pezzi
- Assortimento di chiavi a bussola a macchina lunghe 1/2", 20 pezzi
- Assortimento di chiavi esagonali a testa sferica con impugnatura a T, 6 pezzi
- Assortimento di chiavi Torx a testa sferica con impugnatura a T, 6 pezzi
- N. 3 inserti vuoti
- Funzione antiribaltamento con dispositivo di sicurezza a cassetto singolo
- Pareti laterali forate
- Compatibile con tutti gli altri inserti in EVA Basic e Pro

LISTINO € 4.350,00
€ 3.399,00

Art. 101.401.000

Carrello da officina Basic Line EXTRA LARGO, vuoto



LISTINO € 2.790,00
€ 2.190,00



CARRELLO DA OFFICINA PT800

Portata **450 kg**
(dinamica)



Piano di lavoro in acciaio inox resistente ai solventi



Impugnatura ergonomica con superficie di presa antiscivolo, **KRAFTWERK-DESIGN**

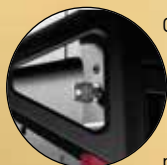

Chiusura centralizzata di tutti i cassetti per mezzo di una serratura a cilindro integrata nella maniglia in posizione protetta



Pareti laterali perforate per una compatibilità ottimale con i nostri sistemi di aggancio

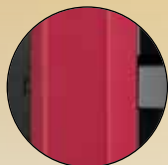

Protezione dei bordi antiurto in **ABS** e **TPR** - plastica

2 ruote piroettanti con freno e 2 ruote fisse



Uso intelligente dello spazio con piccoli cassetti laterali aggiuntivi su entrambi i lati per riporre gli oggetti personali

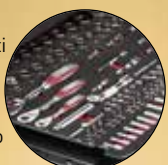

7 cassetti ad estrazione totale con carico utile di 45 kg ciascuno



360° Protezione anche quando il cassetto è aperto grazie al rivestimento degli angoli

Protezione antiribaltamento
(impedisce l'apertura contemporanea di più cassetti)

Art. 101.417.000	L1	L2	L3	ΔT
	800 mm	479 mm	1000 mm	450 kg
L4	600 mm	400 mm	73 mm	45 kg
L5	600 mm	400 mm	152 mm	45 kg

MADE IN GERMANY

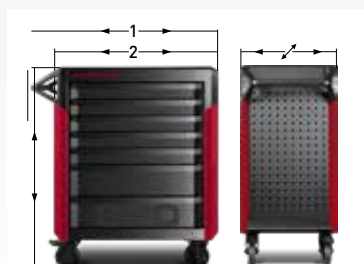

PT800 Carrello da officina, 7 cassetti, vuoto

Art.	↑ mm	↔ mm	↗ mm	↘ mm				400 × 600 mm		ΔT kg	Listino	PROMO
101.417.000	1000	919	800	479	450	7	2 × 150 mm; 5 × 75 mm		45	87	€ 1.529,00	€ 1.149,00

Art. 102.417.005

PT800 Carrello da officina, 7 cassetti, PRO+HT, 189 pz.

- MADE IN GERMANY
- 189 utensili di alta qualità con 7 inserti in EVA
- Cricchetti reversibili da 1/4" + 3/8" + 1/2" e prolunghe
- Chiavi a bussola da 1/4" (6ct.): 3.5 - 14 mm
- Chiavi a bussola da 3/8": 8 - 24 mm
- Chiavi a bussola da 1/2" (6ct.): 10 - 32 mm
- Chiave combinata: 5,5 - 24 mm
- PRO LINE Assortimento di cacciaviti a taglio 4 - 8 mm, PH1 + PH2
- Assortimento di pinze
- Set di martelli e utensili a percussione
- Set utensili da taglio

LISTINO € 2.539,00
€ 1.839,00

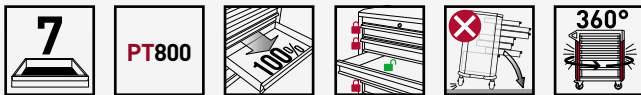
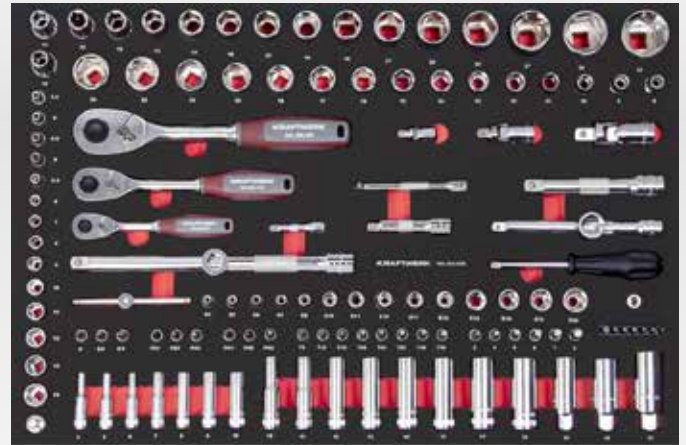

Art. 101.417.000	L1	L2	L3	ΔT	
	L1	800 mm	479 mm	1000 mm	450 kg
	L4	600 mm	400 mm	73 mm	45 kg
	L5	600 mm	400 mm	152 mm	45 kg

MADE IN GERMANY

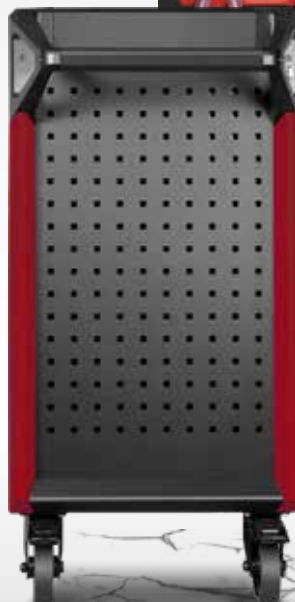

CARRELLO DA OFFICINA PT 1000

Portata **450 kg**
(dinamica)



Piano di lavoro in acciaio inox resistente ai solventi



Impugnatura ergonomica con superficie di presa antiscivolo, **KRAFTWERK-DESIGN**

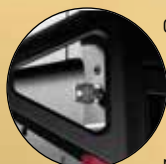

Chiusura centralizzata di tutti i cassetti per mezzo di una serratura a cilindro integrata nella maniglia in posizione protetta

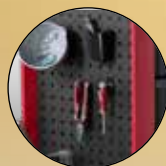

Pareti laterali perforate per una compatibilità ottimale con i nostri sistemi di aggancio

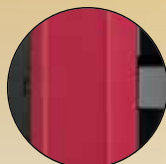

Protezione dei bordi antiurto in **ABS** e **TPR** - plastica



2 ruote piroettanti con freno e 2 ruote fisse

Protezione antibaltamento
(impedisce l'apertura contemporanea di più cassetti)

Uso intelligente dello spazio con piccoli cassetti laterali aggiuntivi su entrambi i lati per riporre gli oggetti personali



7 cassetti ad estrazione totale con carico utile di 45 kg ciascuno

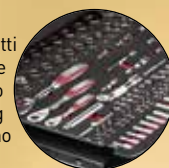

360°-Protezione anche quando il cassetto è aperto grazie al rivestimento degli angoli



Art. 101.517.000	L1	L2	L3	ΔD
	1000mm	479 mm	1000 mm	450 kg
L4	800 mm	400 mm	73 mm	45 kg
L5	800 mm	400 mm	152 mm	45 kg

MADE IN GERMANY

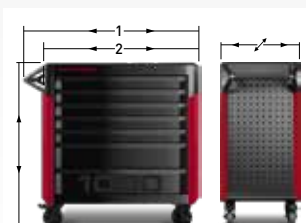

PT1000 Carrello da officina, 7 cassetti, vuoto

Art.	↑ mm	↖ mm	↗ mm	↘ mm	kg		mm mm	800 x 600 mm	kg	ΔD kg	Listino	PROMO
101.517.000	1000	1119	1000	479	450	7	2 x 150 mm; 5 x 75 mm		45	87	€ 1.889,00	€ 1.489,00

Art. 102.517.005

PT1000 Carrello da officina, 7 cassetti, PRO+HT, 221 pz.

- MADE IN GERMANY
- 221 utensili di alta qualità con 10 inserti in EVA
- Chiave combinata: 5.5 - 32 mm
- Cricchetti reversibili da 1/4" + 3/8" + 1/2"
- Bit e prolunghe
- Chiavi a bussola da 1/4": 3.5 - 14 mm
- Chiavi a bussola da 3/8": 8 - 24 mm
- Chiavi a bussola da 1/2": 10 - 32 mm
- Chiavi a bussola con inserto esagonale da 1/2": 5 - 6 - 8 - 10 - 12 mm
- Chiavi a bussola con inserto da 1/2": M5 - M12
- Assortimento di pinze
- PRO LINE Assortimento di cacciaviti a taglio, TX, PH
- Utensili a percussione e da taglio

LISTINO € 3.199,00
€ 2.559,00

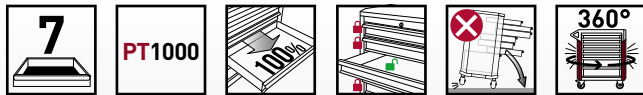

Art. 101.517.000	L1	L2	L3	ΔTD	
	1000mm	479 mm	1000 mm	450 kg	
	L4	800 mm	400 mm	73 mm	45 kg
	L5	800 mm	400 mm	152 mm	45 kg

MADE IN GERMANY

PRO LINE



IL PIÙ VENDUTO



Sportello superiore con cerniera con blocco apertura regolabile



Piano da lavoro in multistrato in faggio da 20 mm con verniciatura all'olio di lino per una maggiore protezione



3 cassetti estraibili con guide su cuscinetti a sfera



**STABILE
E RESISTENTE!**

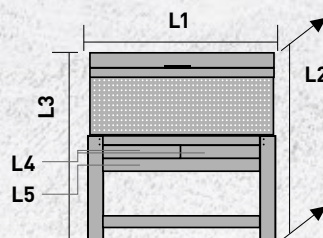

	L1 / mm	L2 / mm	L3 / mm	⚖ kg
	1145	635	1585	80
L4	457	423	93	20
L5	921	483	93	30

Art. 3962

Banco da lavoro

- Solida struttura in acciaio
- Piano da lavoro in multistrato in faggio da 20 mm con verniciatura all'olio di lino per una maggiore protezione
- 3 Cassetti su cuscinetti a sfera
- Completo di parete forata ed armadietto a parete

LISTINO
~~€ 572,00~~
€ 370,00

OFFERTA IMPERDIBILE!

**PICCOLA FUORI
GRANDE DENTRO!**

106 PEZZI



**CASSETTA METALLICA ASSORTITA
LA PIÙ VENDUTA**

SPESSORE LAMIERA 10 DECIMI

Art. 206.000.000

**Cassetta di utensili, attrezzata
1/4" + 1/2", 106 pz.**

- Chiavi combinate: 8 - 19 mm
- Chiavi a cricchetto 1/4" + 1/2"
- Chiavi a bussola 1/4": 3.5 - 10 mm
- Chiavi a bussola 1/2": 10 - 32 mm

220 x 480 x 240 mm | 13 kg



**CON AMPIO
VANO VUOTO
PORTA MINUTERIE**

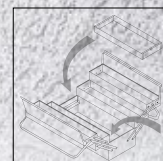

LISTINO ~~€ 389,00~~
€ 295,00

Art. 3944

Valigia di utensili PRO LINE, 1/4", 123 pezzi

- Gli utensili sono riposti in vassoi in schiuma ad alta densità (EVA) con superficie in simil fibra di carbonio
- Chiavi combinate da 8 a 19 mm
- Chiave a cricchetto 1/4", 45 denti
- Chiavi a bussola 1/4" da 3,5 a 14 mm

133 x 400 x 270 mm | 6,5 kg

LISTINO ~~€ 339,00~~
€ 265,00



1/4" 1/4" 4 mm **CrV**

1/4"  3.5-14 mm

1/4" 

4 mm 

 8-19 mm

Art. 3946

Valigia di utensili PRO LINE, 1/4", 151 pezzi

- Gli utensili sono riposti in vassoi in schiuma ad alta densità (EVA) con superficie in simil fibra di carbonio
- Chiavi combinate da 8 a 19 mm
- Chiave a cricchetto 3/8", 45 denti
- Chiavi a bussola 1/4" da 3,5 a 7 mm
- Chiavi a bussola 3/8" da 8 a 24 mm

323 x 433 x 149 mm | 10 kg

LISTINO ~~€ 519,00~~
€ 379,00



1/4" 3/8" 1/4" 4 mm **CrV**

1/4" 3/8"  1/4" 3.5-7 mm
 3/8" 8-24 mm

1/4" 

4 mm 

 8-19 mm

Art. 3948

Valigia di utensili PRO LINE, 1/4" + 1/2", 263 pezzi

- Gli utensili sono riposti in vassoi in schiuma ad alta densità (EVA) con superficie in simil fibra di carbonio
 - Chiavi combinate da 8 a 22 mm
 - Chiavi a cricchetto 1/4"+1/2", 45 denti
 - Chiavi a bussola 1/4" da 3,5 a 14 mm
 - Chiavi a bussola 1/2" da 10 a 32 mm
- 365 x 489 x 178 mm | 14,2 kg

LISTINO ~~€ 720,00~~
€ 495,00

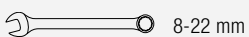
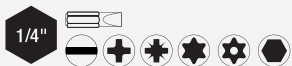
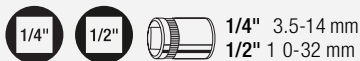

PRO Line

**VALIGIE IN ALLUMINIO
CON UTENSILI PROFESSIONALI**

- PROTEZIONE LATERALE ANTI URTO
- VASSOI ANTI ROVESCIMENTO (EVA MATERIALE ESPANSO AD ALTA DENSITÀ CON SUPERFICIE IN SIMIL FIBRA DI CARBONIO)
- APPOSITE TASCHE CON ELASTICI

QUALITÀ TOP!!!



Art. 202.152.000

Valigia di utensili B152, 1/4" + 3/8", 103 pezzi

- Avvitatore senza fili per inserti 7.2 V, 1500 mAh
- Chiavi combinate da 8 a 19 mm
- Chiave a cricchetto 3/8", 45 denti
- Chiavi a bussola 1/4" da 4 a 6 mm
- Chiavi a bussola 3/8" da 7 a 19 mm
- Tappetino per le ginocchia

375 x 325 x 160 mm | 7,8 kg

LISTINO ~~€ 317,00~~
€ 240,00



Art. 202.143.000

Valigia di utensili B143, 1/4" + 3/8", 102 pezzi

- Chiavi combinate da 8 a 19 mm
- Chiave a cricchetto 3/8", 45 denti
- Chiavi a bussola 1/4" da 4 a 9 mm
- Chiavi a bussola 3/8" da 10 a 24 mm
- Tappetino per le ginocchia

375 x 325 x 160 mm | 7,9 kg

LISTINO ~~€ 280,00~~
€ 210,00



Art. 202.147.000

Valigia di utensili B147, 1/4" + 1/2", 158 pezzi

- Chiavi combinate da 8 a 22 mm
- Chiavi a cricchetto 1/4"+1/2", 45 denti
- Chiavi a bussola 1/4" da 4 a 14 mm
- Chiavi a bussola 1/2" da 10 a 32 mm
- Tappetino per le ginocchia

470 x 375 x 160 mm | 13,9 kg

LISTINO ~~€ 515,00~~
€ 399,00



BASIC Line

VALIGIE IN ALLUMINIO
CON UTENSILI PROFESSIONALI

- PROTEZIONE LATERALE ANTI URTO
- VASSOI ANTI ROVESCIAMENTO (EVA MATERIALE ESPANSO AD ALTA DENSITÀ CON SUPERFICIE LAMINATA)
- APPOSITE TASCHE CON ELASTICI
- NUOVO DESIGN



Art. 202.100.100

Valigia di utensili B100, ABS, 1/4" + 1/2", 170 pezzi

- Chiavi combinate da 8 a 22 mm
- Chiavi a cricchetto 1/4"+1/2", 45 denti
- Chiavi a bussola 1/4" da 4 a 14 mm
- Chiavi a bussola 1/2" da 13 a 32 mm
- Chiave di costruzione per cilindro profilato e tondo 17 + 22 mm

464 x 370 x 178 mm | 13,8 kg

LISTINO ~~€ 625,00~~
€ 489,00



Art. 206.100.000

Cassettiera trasportabile con utensili universali 1/4" + 1/2", 100 pezzi

- Struttura robusta con grande scomparto e 4 cassetti completamente estraibili
- Chiusura centralizzata
- Chiavi a cricchetto da 8 a 19 mm
- Chiavi a cricchetto 1/4" + 1/2", 45 denti
- Chiavi a bussola 1/4" da 4 a 14 mm
- Chiavi a bussola 1/2" da 10 a 32 mm

533 x 340 x 219 mm | 20,25 kg

LISTINO ~~€ 520,00~~
€ 369,00

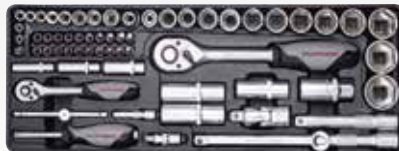

Art. 1046E

Cassettiera trasportabile, VUOTA

- Struttura robusta con grande scomparto e 4 cassetti completamente estraibili
- Chiusura centralizzata

533 x 340 x 219 mm | 5 kg

LISTINO ~~€ 145,00~~
€ 99,00



Art. 201.390.000

Valigia di utensili P390, ABS, VUOTA

- 2 pannelli rimovibili porta attrezzi
- Fondo con divisori modulari
- Numerose tasche
- Compartimenti per documenti e materiale da scrittura

499 x 203 x 425 mm | 5,48 kg

LISTINO ~~€ 195,00~~
€ 145,00



P390

Art. 201.395.000

Valigia di utensili P395, ABS, trolley, VUOTA

- Manico telescopico in gomma, 0 - 565 mm
- 2 Ruote
- 2 pannelli rimovibili porta attrezzi
- Fondo con divisori modulari
- Numerose tasche
- Compartimenti per documenti e materiale da scrittura

472 x 125 x 363 mm | 6 kg

LISTINO ~~€ 225,00~~
€ 179,00



P395



Cassetta metallica, 5 scomparti, VUOTA

- Possibile il blocco della cassetta con lucchetto
- Prodotto di qualità Europea

Art. 3952

LISTINO ~~€ 82,00~~
€ 61,00

430 x 200 x 200 mm | 5,8 kg

Art. 3950

LISTINO ~~€ 92,00~~
€ 69,00

530 x 200 x 200 mm | 6,5 kg



LA PIÙ VENDUTA



BASIC LINE

Art. 204.104.800

Set di chiavi a bussola BASIC LINE, 1/4" + 3/8" + 1/2", 200 pezzi

- Chiavi a cricchetto 1/4" + 3/8" + 1/2"
- Chiavi a bussola 1/4" da 4 a 14 mm
- Chiavi a bussola 3/8" da 10 a 19 mm
- Chiavi a bussola 1/2" da 10 a 32 mm
- Inserti ad esagono cavo da 1/4": 3 - 4 - 5 - 5,5 - 6 - 7 - 8 mm

445 x 330 x 90 mm | 9,1 kg

LISTINO € 205,00
€ 145,00

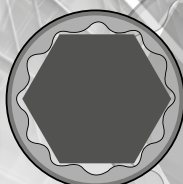

SURFACE™

BUSSOLE CON IMPRONTA SURFACE

NON DANNEGGIANO L'ESAGONO!

Art. 204.100.000

Set di chiavi a bussola BASIC LINE, 1/4", 26 pezzi

- Chiave a cricchetto 1/4"
- Chiavi a bussola 1/4" da 4 a 13 mm

165 x 32 x 89 mm | 576 g

LISTINO ~~€ 32,00~~
€ 22,00



Art. 204.101.000

Set di chiavi a bussola BASIC LINE, 1/4", 42 pezzi

- Chiave a cricchetto 1/4"
- Chiavi a bussola da 4 a 14 mm
- Inserti 1/4"

250 x 150 x 51 mm | 1,3 kg

LISTINO ~~€ 74,00~~
€ 38,90



Art. 204.101.001

Set di chiavi a bussola BASIC LINE, 1/4", 82 pezzi

- Chiave a cricchetto 1/4"
- Chiavi a bussola 1/4" da 4 a 14 mm
- Inserti 1/4"

250 x 150 x 51 mm | 1,4 kg

LISTINO ~~€ 74,00~~
€ 38,90

Art. 204.102.100

Set di chiavi a bussola BASIC LINE, 3/8", 26 pezzi

- Chiave a cricchetto 3/8"
- Chiavi a bussola 3/8" da 6 a 22 mm

295 x 215 x 75 mm | 2,66 kg

LISTINO ~~€ 99,00~~
€ 63,50



Art. 204.102.200

Set di chiavi a bussola BASIC LINE, 1/2", 22 pezzi

- Chiavi a cricchetto 1/2"
- Chiavi a bussola 1/2" da 10 a 32 mm

295 x 215 x 75 mm | 3,8 kg

LISTINO ~~€ 123,00~~
€ 79,00



Art. 204.103.600

Set di chiavi a bussola BASIC LINE, 1/4" + 1/2", 80 pezzi

- Chiavi a cricchetto 1/4" + 1/2", 45 denti
- Chiavi a bussola 1/4" da 4 a 14 mm
- Chiavi a bussola 1/2" da 15 a 32 mm

380 x 302 x 85 mm | 5,85 kg

LISTINO ~~€ 175,00~~
€ 132,00



Art. 204.103.601

Set di chiavi a bussola BASIC LINE, 1/4" + 1/2", 105 pezzi

- Chiavi a cricchetto 1/4" + 1/2"
- Chiavi a bussola 1/4" da 4 a 14 mm
- Chiavi a bussola 1/2" da 10 a 32 mm

380 x 302 x 85 mm | 7,1 kg

LISTINO ~~€ 194,00~~
€ 149,00



Art. 204.105.600

Valigia di utensili BASIC LINE, 1/4" + 1/2", 115 pezzi

- Chiavi combinate da 8 a 22 mm
- Chiavi a cricchetto 1/4" + 1/2"
- Chiavi a bussola 1/4" da 4 a 13 mm
- Chiavi a bussola 1/2" da 14 a 32 mm

540 x 390 x 110 mm | 11 kg

LISTINO ~~€ 349,00~~
€ 269,00



Art. 204.103.500

Valigia di utensili BASIC LINE, 1/4" + 3/8", 96 pezzi

- Chiave combinata da 8 a 19 mm
- Chiave a cricchetto 1/4" + 3/8"
- Chiavi a bussola 1/4" da 4 a 9 mm
- Chiavi a bussola 3/8" da 10 a 19 mm

380 x 302 x 85 mm | 5 kg

LISTINO ~~€ 167,00~~
€ 129,90



Art. 204.104.100

Valigia di utensili BASIC LINE, 3/8", 90 pezzi

- Chiavi combinata da 8 a 19 mm
- Chiave a cricchetto 3/8"
- Chiavi a bussola da 6 a 24 mm

410 x 353 x 93 mm | 6,15 kg

LISTINO ~~€ 190,00~~
€ 145,00



Art. 2057

Set di chiavi a bussola PRO LINE, 3/4", 21 pezzi

- Chiave a cricchetto, manico estensibile da 500 a 800 mm
- Chiavi a bussola da 19 a 50 mm

535 x 383 x 100 mm | 15 kg

LISTINO ~~€ 551,00~~
€ 345,00

PRO LINE



Art. 208.100.000

Astuccio di utensili, 57 pezzi

- Chiavi combinate misure: 8 - 19 mm
- Pinza universale 180 mm
- Pinza regolabile 250 mm
- Chiave a rullino 250 mm/10"
- Serie di chiavi maschio esagonali misure: 1,5 - 10 mm
- Assortimento di inserti da 1/4", 33 pezzi
- Cutter
- Impugnatura 1/4" x 100 mm

367 x 255 x 50 mm | 3,08 kg



LISTINO ~~€ 119,00~~
€ 95,00



CAPACITÀ 24 L

(senza contenuto)



Borsa per utensili

- 12 tasche esterne e 8 interne
- Chiusura a cerniera, maniglia e tracolla imbottita
- Fabbricazione robusta in tessuto poliestere impermeabile 600 Deniers

Art.	mm	kg	L	kg max.
3955	350 x 400 x 220 mm	1.5	24 l	15

LISTINO ~~€ 46,70~~
€ 33,50

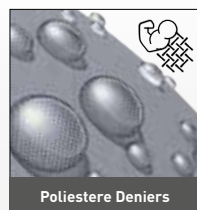

CAPACITÀ 40 L



(senza contenuto)



LISTINO ~~€ 77,00~~
€ 50,00

CAPACITÀ 10 L

Borsa per utensili con maniglia in metallo

- Tasca grande esterna e interna dotati con cerniere, 8 tasche interne
- 14 elastici all'interno
- Maniglia in solido acciaio inossidabile con imbottitura ergonomica
- Tracolla imbottita
- Pareti laterali rinforzati
- Chiusura con cerniera del coperchio
- Fondo in solido PVC
- Fabbricazione robusta in tessuto poliestere impermeabile 1680 Deniers

Art.	mm	kg	L	kg max.
3958	300 x 390 x 210 mm	2.5	10 l	18

(senza contenuto)



Borsa per utensili con maniglia in metallo

- 4 tasche sul fronte, 6 sul retro, 1 tasca laterale, 8 tasche interne
- 8 elastici all'interno
- Tasca speciale per seghe sul fronte
- Maniglia in solido acciaio inossidabile con imbottitura ergonomica
- Con cerniere e tracolla imbottita
- Con delle chiusure velcro sulla copertura per fissare utensili lunghi come dei livelli a bolla
- Copertura rimovibile e chiusura con cerniera
- Pareti laterali rinforzati e fondo in solido PVC
- Fabbricazione robusta in tessuto poliestere impermeabile 1680 Deniers

Art.	mm	kg	L	kg max.
3959	370 x 440 x 260 mm	3.5	40 l	23

LISTINO ~~€ 127,00~~
€ 79,00

Art. 3404-51

Serie di chiavi combinate a cricchetto reversibili Clickraft, 6 pezzi

- Misure: 8-10-12-13-17-19 mm
- In confezione di tela canvas
- Leva di inversione integrata
- Con 72 denti
- Lucide nichelate e cromate

REVERSIBILI

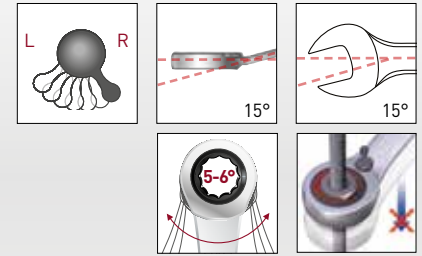

LISTINO ~~€ 137,00~~
€ 96,00

Art. 3400-50

Serie di chiavi combinate a cricchetto, Clickraft, 4 pezzi

- Misure: 10-13-17-19 mm
- 72 denti
- Lucide nichelate e cromate
- In scatola di cartone

CRICCHETTO

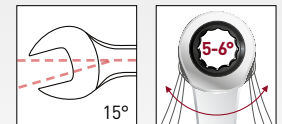

LISTINO ~~€ 74,00~~
€ 51,00

Art. 3403-51

Serie di chiavi combinate a cricchetto snodate Clickraft, 6 pezzi

- Con 72 denti
- Lucide nichelate e cromate
- Misure: 8-10-12-13-17-19 mm
- In confezione di tela canvas

SNODATE

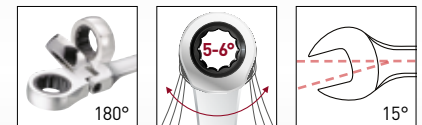
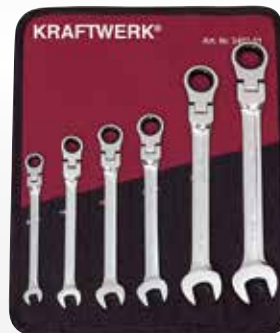

LISTINO ~~€ 158,00~~
€ 113,00

Art. 3404-1019

Chiave combinata a cricchetto reversibile Clickraft

- Misure: 10x13-17x19 mm
- Leva di inversione integrata
- Con 72 denti
- Lucide nichelate e cromate

LISTINO ~~€ 41,40~~
€ 26,00



**1 CHIAVE
4 MISURE**

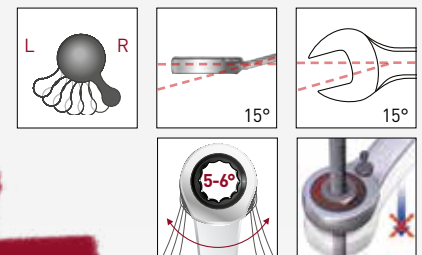

Art. 3404-4x2

Serie di chiavi combinate a cricchetto reversibili Clickraft, 2 pezzi

- Misure: 8x10-12x13, 16x17-18x19 mm
- Leva di inversione integrata
- Con 72 denti
- Lucide nichelate e cromate

**2 CHIAVI
8 MISURE**

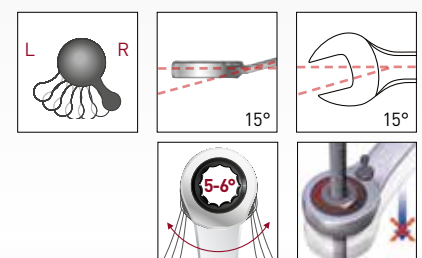

LISTINO ~~€ 70,00~~
€ 47,00

Art. 3557R

Serie di chiavi combinate, 18 pezzi

- In confezione di tela canvas
- Misure: 5,5-6-7-8-9-10-11-12-13-14-15-16-17-18-19-20-21-22 mm
- Lucida nichelata e cromata

LISTINO ~~€ 115,00~~
€ 74,00

COMBIMATE



Art. 3558R

Serie di chiavi combinate, 4 pezzi

- In confezione di tela canvas
- Misure: 24-27-30-32 mm
- Lucida nichelata e cromata

LISTINO ~~€ 91,00~~
€ 55,00

COMBIMATE



Art. 3554R

Serie di chiavi combinate, 26 pezzi

- In confezione di tela canvas
- Misure: 5,5-6-7-8-9-10-11-12-13-14-15-16-17-18-19-20-21-22-23-24-25-26-27-28-30-32 mm
- Lucida nichelata e cromata

LISTINO ~~€ 290,00~~
€ 184,00

COMBIMATE



Art. 3553R

Serie di chiavi a forchetta doppie, 10 pezzi

- In confezione di tela canvas
- Misure: 6x7-8x9-10x11-12x13-14x15-16x17-18x19-21x22 mm
- Lucida nichelata e cromata

LISTINO ~~€ 95,00~~
€ 68,00



Cricchetti reversibili BASIC LINE

- DIN 3122 / ISO 3315
- Leva senso orario/antiorario integrata
- Meccanismo di estrazione veloce degli inserti
- 72 denti con angolo di ritorno di 5°
- Manico ergonomico antiscivolo a 2 componenti
- Per bussole, inserti, etc. con attacco quadrato DIN 3120 - C 6.3, ISO 1174



Art. n°	Descrizione	Listino	Promo
303.100.000	Cricchetto reversibile, 1/4"	€ 26,00	€ 18,50
303.100.100	Cricchetto reversibile, 3/8"	€ 32,00	€ 22,90
303.100.200	Cricchetto reversibile, 1/2"	€ 39,00	€ 28,50

Cricchetti reversibili PRO LINE

- DIN 3122 / ISO 3315
- Leva senso orario/antiorario integrata
- Meccanismo di estrazione veloce degli inserti
- 72 denti con angolo di ritorno di 5°
- Manico ergonomico antiscivolo a 2 componenti
- Per bussole, inserti, etc. con attacco quadrato DIN 3120 - C 6.3, ISO 1174

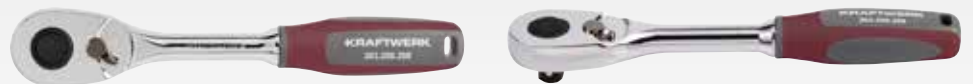

Art. n°	Descrizione	Listino	Promo
303.200.000	Cricchetto reversibile, 1/4"	€ 44,00	€ 27,00
303.200.100	Cricchetto reversibile, 3/8"	€ 52,00	€ 35,50
303.200.200	Cricchetto reversibile, 1/2"	€ 72,00	€ 45,50

Chiave a rullino

- Testa a forchetta inclinata a 15°
- Versione svedese con mandrino
- Con scala graduata
- Cromo vanadio
- DIN 3117 / ISO 6787



Art. n°	Apertura	Lunghezza	Listino	Promo
2404	0 - 14 mm	100 mm	€ 13,60	€ 10,00
2406	0 - 20 mm	150 mm	€ 14,90	€ 10,00
2408	0 - 25 mm	200 mm	€ 18,20	€ 12,50
2410	0 - 30 mm	250 mm	€ 19,90	€ 14,00
2412	0 - 35 mm	300 mm	€ 28,00	€ 19,00
2415	0 - 45 mm	375 mm	€ 59,00	€ 42,00
2418	0 - 55 mm	400 mm	€ 103,00	€ 73,00



Art. 330990

Set di chiavi a bussola, 1/2", Combi, 10 pezzi

- Su pratica guida magnetica in alluminio
- Misure:
Millimetri: 10-11-12-13-14-15-16-17-18-19
Pollici: 3/8"-7/16"-15/32"-1/2"-19/32"-5/8"-3/4"
Torx: E12-E14-E16-E18-E20-E22-E24
Xzn: M12-M14-M16-M18



COMBI

LISTINO ~~€ 67,00~~
€ 45,00

Art. 330991

Set di chiavi a bussola, 1/2", Combi, 7 pezzi

- Su pratica guida magnetica in alluminio
- Misure:
Millimetri: 20-21-22-24-27-30-32
Pollici: 25/32"-13/16"-7/8"-15/16"-1-1/16"-1-3/16"-1-1/4"
Torx: E26-E28-E30-E34-E38-E40



COMBI

LISTINO ~~€ 81,00~~
€ 54,00

Art. 130990

Set di chiavi a bussola, 1/4", Combi, 13 pezzi

- Su pratica guida magnetica in alluminio
- Misure:
Millimetri: 4-4.5-5-5.5-6-7-8-9-10-11-12-13-14
Pollici: 5/32"-7/32"-1/4"-5/32"-5/16"-11/32"-3/8"-
7/16"-15-32"-12"
Torx: E5-E6-E8-E10-E12-E14-E16-E18
Xzn: M5-M6-M8-M9-M10- M12-M14-M16-M18



COMBI

LISTINO ~~€ 53,00~~
€ 35,50

Art. 101990

Set di chiavi a bussola lunghe 1/4", 12 pezzi

- Su pratica guida magnetica in alluminio
- Misure: 4-4.5-5-5.5-6-7-8-9-10-11-12-13 mm



LISTINO ~~€ 61,00~~
€ 39,00

Art. 320099

Set di chiavi a bussola, 1/2", E-TX, 8 pezzi

- Su pratica guida magnetica in alluminio
- Misure: E10-E12-E14-E16-E18-E20-E22-E24



LISTINO ~~€ 65,00~~
€ 46,00

Art. 326099

Set di chiavi a bussola con inserto esagonale, 1/2", 8 pezzi

- Su pratica guida magnetica in alluminio
- Misure: 5-6-7-8-10-12-14-17 mm



LISTINO ~~€ 92,00~~
€ 58,00

Chiavi dinamometriche ERGOKRAFT



**PRECISIONE
+/- 4%**

Chiave dinamometrica ERGOKRAFT

- Cassa in acciaio temprato
- Rilasci di coppia chiaramente udibili
- Manico ergonomico a 2 componenti
- Incluso test di certificazione DIN EN ISO 6789 -2:2017 con numero di serie univoco
- Serraggio preciso per minimo 5.000 cicli
- Scale di valori in Nm e Lb.ft.

Art. n°	Descrizione	Listino	Promo
3231	1/4", 2,5-12 Nm, 20-105 Lb.in, 285 mm	€ 127,00	€ 85,00
3232	1/4", 4-20 Nm, 30-180 Lb.in, 285 mm	€ 122,00	€ 84,00
3233	3/8", 10-60 Nm, 9-45 Lb.ft, 383 mm	€ 134,00	€ 96,00
3234	3/8", 25-125 Nm, 20-90 Lb.ft, 438 mm	€ 150,00	€ 99,50
3235	1/2", 40-200 Nm, 30-150 Lb.ft, 463 mm	€ 158,00	€ 107,00
3236	1/2", 65-335 Nm, 50-250 Lb.ft, 523 mm	€ 169,00	€ 121,00
3237	3/4", 160-800 Nm, 120-600 Lb.ft, 1040 mm	€ 889,00	€ 581,00

HIGHTECH 3C PRO LINE

La gamma di pinze industriali

in acciaio speciale per utensili, forgiato a caldo, temprato a olio, con taglienti di precisione temprati a induzione, con **finitura in titanio** antiriflesso e non riflettente. Massima presa ed ergonomia grazie ai manici "Soft-Grip" con la più recente tecnologia a **3 componenti**, con protezione dagli urti.



Art. 308.000.000

Set di 4 pinze HIGHTECH

- Pinza universale, 180 mm (Art. 4271-180)
- Tronchese a taglio diagonale, 180 mm (Art. 4272-180)
- Pinza a becchi mezzotondi, 205 mm (Art. 4275-205)
- Pinza regolabile HIGHTECH a cerniera, 240 mm (Art. 4223-240)
- Clip di sicurezza per pinze HIGHTECH

LISTINO ~~€ 158,00~~
€ 119,00

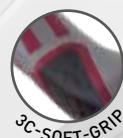

ERGOKRAFT

Impugnatura ergonomica a 2 componenti

per il massimo comfort di presa e una trasmissione ottimale della potenza, in acciaio al cromo vanadio, cromato e lucidato.

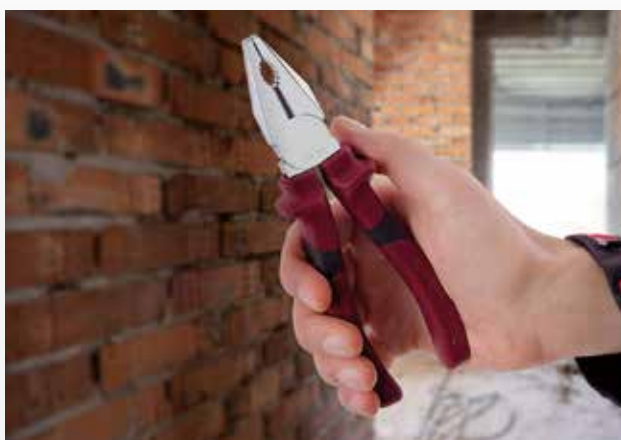

Art. 3292

Set di 4 pinze ERGOKRAFT

- Pinza combinata, 180 mm (Art. 3281-180)
- Tronchese laterale, 160 mm (Art. 3282-160)
- Pinza a becchi mezzotondi, 200 mm (Art. 3285-200)
- Pinza regolabile, 160 mm (Art. 2221-250)

LISTINO ~~€ 85,00~~
€ 57,00



BASIC LINE

Impugnatura ergonomica a 2 componenti

per un maggiore comfort e una migliore presa, in acciaio al cromo vanadio. Superficie gommata dall'elegante design grigio-nero, BASIC LINE è una linea economica alternativa a ERGOKRAFT e HIGHTECH, di ottima qualità.

Art. 308.110.000SET

Set di 3 pinze BASIC LINE

- BASIC LINE Pinza universale, 180 mm (Art. 308.100.000)
- BASIC LINE Tronchese laterale, 160 mm (Art. 308.101.000)
- BASIC LINE Pinza a becchi mezzotondi, 200 mm (Art. 308.102.000)

LISTINO ~~€ 43,70~~
€ 34,00



NOVITÀ

Art. 2212

Set di pinze per anelli Seeger, 4 pezzi

- Pinza a becchi diritti per anelli esterni, con molla (Art. 2212-A2)
- Pinza a becchi diritti per anelli interni (Art. 2214-J2)
- Pinza a becchi piegati a 90° per anelli interni (Art. 2215-J21)
- Pinza a becchi piegati a 90° per anelli esterni (2213-A21)



LISTINO ~~€72,00~~
€ 45,00



Art. 2213-A21

Art. 99067

Assortimento di 3 pinze regolabili

- Pinza regolabile autobloccante 175 mm (art. 3290-175)
- Pinza regolabile autobloccante 250 mm (art. 3290-250)
- Pinza regolabile autobloccante 300 mm (art. 3290-300)

LISTINO ~~€59,00~~
€ 45,50



Art. 308.300.160

Tronchese ErgoKraft isolato VDE a taglio diagonale 160 mm



VDE GS 1000 V IEC 60900

LISTINO ~~€27,00~~
€ 19,50

Art. 308.310.200

Pinza ErgoKraft isolata VDE, becchi mezzotondi lunghi 200 mm



VDE GS 1000 V IEC 60900

LISTINO ~~€28,50~~
€ 20,50

Art. 308.300.180

Pinza universale, isolata VDE 1000 V, 180 mm



VDE GS 1000 V IEC 60900

LISTINO ~~€30,00~~
€ 22,00



Pinza universale, Hightech

- Formato americano
- Forgiata in acciaio speciale
- Leva migliorata e precisa
- Per il taglio di fili morbidi e duri
- Taglienti induriti a induzione
- Utile come chiave M8 - M10 / Ø 11 - 17 mm
- Zona grip per materiali rotondi e piatti
- Impugnatura a 3 componenti



Art. n°	Descrizione	Listino	Promo
4271-165	165 mm / 6,1/2"	€ 29,00	€ 23,90
4271-180	180 mm / 7"	€ 32,00	€ 26,00
4271-205	205 mm / 8"	€ 34,00	€ 27,90

Tronchese a taglio diagonale Hightech

- Per il taglio di fili morbidi e duri
- Forgiato in acciaio speciale
- Leva migliorata e precisa
- Taglienti di precisione
- Funzione antiscivolo
- Taglienti induriti a induzione
- Impugnatura a 3 componenti



Art. n°	Descrizione	Listino	Promo
4272-145	145 mm / 5,3/4"	€ 32,00	€ 25,60
4272-160	160 mm / 6,1/2"	€ 38,00	€ 29,50
4272-180	180 mm / 7"	€ 42,00	€ 33,00

Art. 4274-200

Tronchese antisforzo a taglio diagonale Hightech

- 200 mm / 8"
- Per il taglio di fili morbidi e duri
- Anche per legare la rete d'acciaio
- Forgiato in acciaio speciale
- Leva migliorata e precisa
- Taglienti di precisione
- Taglienti induriti a induzione

LISTINO ~~€ 55,00~~
€ 43,50

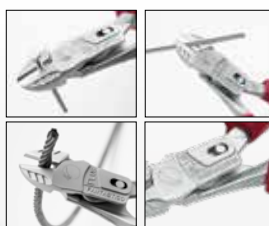

Pinza a becchi mezzotondi, Hightech

- Per il taglio di fili morbidi e duri
- Forgiata in acciaio speciale
- Leva migliorata e precisa
- Taglienti interni seghettati
- Taglienti induriti a induzione
- Impugnatura a 3 componenti



Art. n°	Descrizione	Listino	Promo
4275-170	170 mm / 6,3/4"	€ 32,00	€ 25,90
4275-205	205 mm / 8"	€ 42,00	€ 31,50

Art. 4276-205

Pinza a becchi mezzotondi lunghi piegati a 45° Hightech

- 205 mm / 8"
- Per il taglio di fili morbidi e duri
- Forgiata in acciaio speciale
- Leva migliorata e precisa
- Taglienti interni seghettati
- Taglienti induriti a induzione
- Impugnatura a 3 componenti

LISTINO ~~€ 44,00~~
€ 33,00

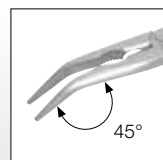

Pinza regolabile autobloccante a ganasce concave

- Con vite di regolazione e leva di rilascio
- Ganasce in acciaio cromo molibdeno
- Corpo in lamiera d'acciaio

Art. n°	Descrizione	Listino	Promo
3292-175	175 mm / 7" - Apertura 0-43 mm	€ 24,40	€ 15,70
3292-250	250 mm / 10" - Apertura 0-58 mm	€ 25,50	€ 16,50



Art. 2224

Set rivetti assortiti e rivettatrice

- Realizzata in pressofusione di alluminio
- Molla di apertura per espulsione mandrino
- Design sottile

Assortimento di rivetti:

- Ø 2,4 mm, 20 pezzi
- Ø 3,2 mm, 20 pezzi
- Ø 4,0 mm, 20 pezzi
- Ø 4,8 mm, 20 pezzi

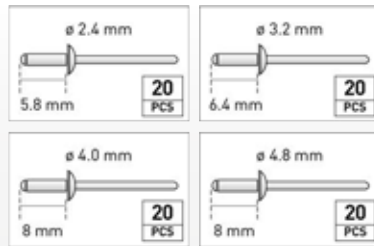

LISTINO ~~€ 55,00~~
€ 36,50



Art. 3290-230

Pinza per capicorda preisolati 5 in 1, Ergokraft, 1,5 - 6 mm³

- 230 mm
- In acciaio indurito (54 HRC)
- Realizzata con bordi molati per uso professionale e industriale
- 5 in 1: Tronchese taglia fili
- Pinza a crimpare per terminali isolati
- Troncabulloni
- Pinza a crimpare per terminali a barile
- Spelafili per cavi



LISTINO ~~€ 30,80~~
€ 21,00



PRO LINE

 Made in Germany

Cappello senza saldature per un attrito minimo

Impronta riportata sulla calotta sferica per una rapida individuazione

Foro sull'impugnatura per una migliore appendibilità ed esposizione degli utensili

Impugnatura che permette al giravite di girare rapidamente tra le dita

Longevità dovuta all'utilizzo di acciaio al cromo molibdeno vanadio

CrMo

Lama durevole e resistente



Art. 105.402.001

Set PRO LINE di giraviti intaglio e PH, 5 pezzi

- Giraviti Intaglio/Phillips
- SL 4.0-5.5-6.5 mm / PH1 PH2
- Manico ergonomico bimateriale
- Acciaio al cromo molibdeno vanadio

LISTINO

~~€ 46,00~~

€ 34,50



Art. 105.402.003

Set PRO LINE di giraviti TX, 5 pezzi

- Giraviti TX
- TX 10-15-20-25-30
- Manico ergonomico bimateriale
- Acciaio al cromo molibdeno vanadio

LISTINO

~~€ 49,50~~

€ 36,00

Set di giraviti PRO LINE

ERGOKRAFT



Testa di presa
rotonda e liscia
per scivolare
senza problemi
nel palmo
della mano

Ampia apertura
per appenderlo
comodamente
alla parete
degli attrezzi

Impugnatura
ergonomica a
2 componenti

Incavi per le dita
e protezione
antiscivolo

Acciaio S2 per
un uso
professionale
continuo



Lama di
precisione
secondo
Norme DIN/ISO

Art. 4160

Set di giraviti Ergokraft, 7 pezzi

- Giraviti Intaglio/Phillips
- Manico ergonomico bimatereale
- Qualità S2
- Acciaio al Cromo Vanadio

LISTINO ~~€ 39,30~~
€ 25,00

	⊖	Art. 4110-1	0.6 x 3 mm
		Art. 4110-2	0.8 x 4 mm
		Art. 4110-3	1.0 x 5 mm
		Art. 4110-4	1.1 x 6 mm
		Art. 4110-5	1.2 x 8 mm
	+	Art. 4115-1	PH 1
		Art. 4115-2	PH 2



Art. 4161

Set di giraviti Ergokraft, 7 pezzi

- Giraviti Intaglio/Pozidriv
- Manico ergonomico bimatereale
- Qualità S2
- Acciaio al Cromo Vanadio

LISTINO ~~€ 40,30~~
€ 26,00

	⊖	Art. 4110-1	0.6 x 3 mm
		Art. 4110-2	0.8 x 4 mm
		Art. 4110-3	1.0 x 5 mm
		Art. 4110-4	1.1 x 6 mm
		Art. 4110-5	1.2 x 8 mm
	+	Art. 4120-1	PZ 1
		Art. 4120-2	PZ 2



Art. 4168

Assortimento di giraviti ed inserti, 24 pezzi

- Giraviti Intaglio/Phillips/TORX/TX
- Manico ergonomico bimatereale
- Qualità S2
- Acciaio al Cromo Vanadio

LISTINO ~~€ 92,00~~
€ 61,00

	⊖	Art. 4110-1	0.6 x 3 mm	Art. 4110-4	1.1 x 6 mm
		Art. 4110-2	0.8 x 4 mm	Art. 4110-5	1.2 x 8 mm
		Art. 4110-3	1.0 x 5 mm	Art. 4110-6	1.6 x 10 mm
	⊖	Art. 4112-2	1.1 x 6 mm		
	+	Art. 4115-0	PH 0	Art. 4115-2	PH 2
		Art. 4115-1	PH 1	Art. 4115-3	PH 3
	+	Art. 4117-2	PH 2		
	+	Art. 4120-0	PZ 0	Art. 4120-2	PZ 2
		Art. 4120-1	PZ 1	Art. 4120-3	PZ 3
	○	Art. 4128	1/4"		
	★	T10-T15-T20-T25-T27-T30-T40			



+ 380 x 250 x 72 mm

Set di giraviti ERGOKRAFT

Art. 4165

Serie di giraviti Ergokraft, 8 pezzi

- Giraviti TORX
- Misure: T8 - T10 - T15 - T20 - T25 - T27 - T30 - T40
- Manico ergonomico bimateriale
- Qualità S2
- Acciaio al Cromo Vanadio

LISTINO ~~€ 48,80~~
€ 31,90



- Art. 4125-08 T8
- Art. 4125-10 T10
- Art. 4125-15 T15
- Art. 4125-20 T20
- Art. 4125-25 T25
- Art. 4125-27 T27
- Art. 4125-30 T30
- Art. 4125-40 T40

Art. 4166

Serie di giraviti Ergokraft, 8 pezzi

- Giraviti TX Tamper
- Misure: T8 - T10 - T15 - T20 - T25 - T27 - T30 - T40
- Manico ergonomico bimateriale
- Qualità S2
- Acciaio al Cromo Vanadio

LISTINO ~~€ 49,90~~
€ 33,00



- Art. 4126-08 TR8
- Art. 4126-10 TR10
- Art. 4126-15 TR15
- Art. 4126-20 TR20
- Art. 4126-25 TR25
- Art. 4126-27 TR27
- Art. 4126-30 TR30
- Art. 4126-40 TR40

Art. 3157

Serie di giraviti Ergokraft isolati 1000V, 8 pezzi

- Giraviti Intaglio/Phillips
- Manico ergonomico bimateriale come da IEC 60900
- Qualità S2
- Acciaio al Cromo Vanadio
- Con tester di tensione

LISTINO ~~€ 49,90~~
€ 35,00



- Art. 3132-1 2.5 x 75 mm
- Art. 3132-4 4.0 x 100 mm
- Art. 3132-5 5.5 x 125 mm
- Art. 3132-6 6.5 x 150 mm



- Art. 3135-0 PH 0 x 60 mm
- Art. 3135-1 PH 1 x 80 mm
- Art. 3135-2 PH 2 x 100 mm



- Art. 2138 100-250 V



1000 V
IEC 60900

1000 V



Art. 3177

Serie di giraviti di precisione Ergokraft, 8 pezzi

- Per viti a testa con intaglio e viti con impronta Phillips
- Per lavori di alta precisione
- Con cappuccio girevole
- Impugnatura a 2 componenti

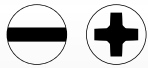

+ 380 x 250 x 72 mm



- + Art. 3177-00 PH 00
- Art. 3177-0 PH 0
- Art. 3177-1 PH 1



- Art. 3177-20 0.45 x 2.0 mm
- Art. 3177-24 0.50 x 2.4 mm
- Art. 3177-30 0.60 x 3.0 mm
- Art. 3177-35 0.65 x 3.5 mm
- Art. 3177-40 0.80 x 4.0 mm

LISTINO ~~€ 36,10~~
€ 24,00

Art. 3178

Serie di giraviti di precisione Ergokraft, 8 pezzi

- Per viti con impronta TX
- Per lavori di alta precisione
- Con cappuccio girevole
- Impugnatura a 2 componenti



+ 380 x 250 x 72 mm

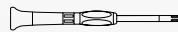

- Art. 3178-05 T5
- Art. 3178-06 T6
- Art. 3178-07 T7
- Art. 3178-08 T8



- Art. 3179-09 T9
- Art. 3179-10 T10
- Art. 3179-15 T15
- Art. 3179-20 T20

LISTINO ~~€ 36,10~~
€ 24,00

Art. 3181

Assortimento universale inserti e portainseri di precisione, 24 pezzi

- Bit da 45 mm: intaglio, Philips, Pozidriv, TORX®, esagonali

- 5 - 0.8-1.0-1.5-2.0-3.0 mm
- 4 - PH 000-00-0-1
- 3 - T3-T4-T5
- 5 - T6-T8-T9-T10-T15
- 6 - 0.7-0.9-1.3-1.5-2.0-2.5 mm

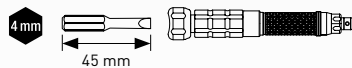

LISTINO ~~€ 51,00~~
€ 34,60



+ 178 x 89 x 35 mm

Art. 3601

Serie di chiavi maschio esagonali, 9 pezzi

- Durezza estrema
- Con gancio e foro
- Acciaio al Cromo Vanadio
- Misure: 1,5-2-2,5-3-4-5-6-8-10 mm

~~€ 11,80~~
€ 7,90



DIN / ISO 2936



Art. 3605

Serie di chiavi maschio con impronta TORX®, 9 pezzi

- Misure: T10-T15-T20-T25-T27-T30-T40-T45-T50

~~€ 23,40~~
€ 15,00



Art. 3602

Serie di chiavi maschio esagonali lunghe, 10 pezzi

- Durezza estrema
- Con estremità sferica sul lato lungo
- Angolo di utilizzo maggiore di 25°
- Acciaio al Cromo Vanadio
- Misure: 1,5-2-2,5-3-4-5-6-7-8-10 mm

~~€ 24,40~~
€ 16,50



DIN / ISO 2936

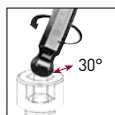

Art. 3607

Serie di chiavi maschio extra lunghe con impronta TORX®, 9 pezzi

- Extra lunghe e con braccio corto
- Misure: T10-T15-T20-T25-T27-T30-T40-T45-T50
- Durezza estrema
- Acciaio al Cromo Vanadio

~~€ 35,00~~
€ 23,50



Art. 3604

Serie di chiavi maschio esagonali extra lunghe, 10 pezzi

- Durezza estrema
- Con estremità sferica sul lato lungo
- Angolo di utilizzo maggiore di 25°
- Acciaio al Cromo Vanadio
- Misure: 1,5-2-2,5-3-4-5-6-7-8-10 mm

~~€ 27,00~~
€ 17,50



DIN / ISO 2936



Art. 3608

Serie di chiavi maschio piegate con testa sferica per viti con impronta TX, 9 pezzi

- Misure: T10 - T15 - T20 - T25 - T27 - T30 - T40 - T45 - T50
- Lunghe, lucide e cromate satinato

~~€ 38,00~~
€ 27,00

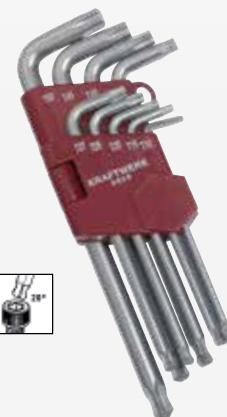

Art. 307.800.009

Serie di chiavi maschio esagonali colorate, 9 pezzi

- Con estremità sferica
- Misure: 1,5-2-2,5-3-4-5-6-8-10 mm
- Verniciatura a polvere con assegnazione del colore ad ogni dimensione
- Chiavi extra lunghe e con testa corta con angolazione di 100° anche per punti di difficile accesso

~~€ 40,30~~
€ 27,00



Art. 307.801.009

Serie di chiavi maschio extra lunghe con impronta TORX®, 9 pezzi

- Con estremità sferica
- Verniciatura a polvere con assegnazione del colore ad ogni dimensione
- Chiavi extra lunghe e con testa corta con angolazione di 100° anche per punti di difficile accesso
- Misure: T10-T15-T20-T25-T27-T30-T40-T45-T50

~~€ 49,90~~
€ 35,00



Art. 2592SET

Serie di 5 chiavi esagonali a T con snodo extra lungo

- Misure: 8-10-13-17-19 mm



LISTINO ~~€ 149,40~~
€ 112,00



Art. 2593SET

Serie di 6 chiavi a T maschio esagonali

- 2 estremità con profilo esagonale e 1 estremità con profilo esagonale a testa sferica

- Misure: 2,5-3-4-5-6-8

LISTINO ~~€ 88,50~~
€ 66,00



Art. 3636SET

Serie di 6 chiavi maschio esagonale con impugnatura a T

- 2 estremità con profilo esagonale e 1 estremità con profilo esagonale a testa sferica

- Misure: 2,5-3-4-5-6-8

LISTINO ~~€ 63,80~~
€ 44,00



Art. 306.378.001

Cacciavite a cricchetto 12 funzioni in 1

- 1 cacciavite a cricchetto
- Assortimento di 12 punte 1/4" x 25 mm
- 3 pezzi 4 - 5 - 6 mm
- 3 pezzi PH1 - PH2 - PH3
- 3 pezzi T15 - T20 - T25
- 3 pezzi H3 - H4 - H5

LISTINO ~~€ 25,00~~
€ 16,00

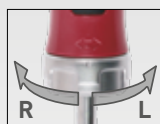

12 IN



35 x 215 x 40 mm

Art. 306.378.005

Pratica impugnatura per bussole con doppia funzione

- Con attacco quadro per bussole da 6,3 mm 1/4" e bussola esagonale per inserti da 6,3 mm 1/4"
- Lunghezza del manico: 120 mm
- Lunghezza lama: 110 mm

LISTINO ~~€ 14,90~~
€ 9,90



37 x 220 x 35 mm

Art. 306.378.002

Set di giraviti a cricchetto 1/4", 53 pezzi

- Acciaio S2 con anello colorato per una migliore identificazione degli inserti
- 1 pz. giravite a cricchetto con impugnatura a T
- 1 pz. 100 mm supporto magnetico
- 1 pz. prolunga flessibile da 120 mm
- 1 pz. giravite di precisione
- 1 pz. giravite di precisione da 60 mm
- Inserti (1/4" x 25 mm):
 - 4 pz. PH: 0 - 1 - 2 - 3
 - 4 pz. PZ: 0 - 1 - 2 - 3
 - 4 pz. SL: 3 - 4 - 5 - 6 mm
 - 4 pz. HEX: 3 - 4 - 5 - 6 mm
 - 7 pz. TX: T10 - T15 - T20 - T25 - T27 - T30 - T40
- 1 pz. adattatore
- Inserti di precisione (4 x 28 mm):
 - 4 pz. SL: 1 - 1,5 - 2 - 2,5 mm
 - 2 pz. PZ: 000-00
 - 6 pz. TX: T4 - T5 - T6 - T7 - T8 - T9
 - 6 pz. esagono: 0,7 - 0,9 - 1,3 - 1,5 - 2,0 - 2,5 mm
 - 6 pz. chiave a bussola 1/4": 5 - 6 - 7 - 8 - 9 - 10



LISTINO ~~€ 39,00~~
€ 24,00



100 x 155 x 50 mm

Art. 306.378.003

Cacciavite a cricchetto 1/4", 25 pezzi

- Acciaio temprato S2
- 1 pz. cacciavite a cricchetto
- 1 pz. supporto magnetico
- Inserti (6.35 x 25 mm)
- 3 pz. PH: 1 - 2 - 3
- 3 pz. PZ: 1 - 2 - 3
- 4 pz. SL: 3 - 4 - 5 - 6 mm
- 3 pz. HEX: 4 - 5 - 6 mm
- 4 pz. TX: T10 - T15 - T20 - T25
- 1 pz. adattatore
- 5 pz. chiave a bussola 1/4": 5 - 6 - 7 - 8 - 9 mm

LISTINO ~~€ 35,00~~
€ 19,00



145 x 95 x 38 mm

Art. 306.378.004

Set di inserti professionali per avvitatori ad impulsi con punte di torsione ad impatto in acciaio S2 1/4", 29 pezzi

Gli inserti a percussione con punte di precisione consentono un migliore adattamento rispetto agli inserti tradizionali. Le punte possono essere ordinate singolarmente grazie ad un meccanismo di inserimento e disinserimento a clip

- Punta di torsione Impcat, 25 mm
- 6 pz. PH: 1 - 2 - 2 - 2 - 2 - 3
- 1 pz. PZ2
- 1 pz. TX T20
- Punta di torsione Impcat, 50 mm
- 6 pz. PH: 1 - 2 - 2 - 2 - 2 - 3
- 2 pz. PZ: 2 - 2
- 4 pz. TX: T10 - T15 - T20 - T25
- Punta di torsione Impcat, 89 mm
- 3 pz. PH: 2 - 2 - 3
- 1 pz. PZ2
- 3 pz. bussole da 65 mm:
- M6 - M8 - M10
- 1 pz. 60 mm portabit in acciaio inox
- 1 pz. 50 mm 3/8" portabit



LISTINO ~~€ 59,00~~
€ 45,00



238 x 230 x 47 mm

Art. 99073

Set di chiavi a bussola 1/4", 38 pezzi

- Cricchetto reversibile da 1/4"
- Maniglia/estensione a innesto da 1/4"
- Prolunghe da 1/4": 50 - 100 mm
- Giunto universale da 1/4"
- Bussole 1/4": 5,5 - 6 - 7 - 8 - 9 - 10 - 11 - 12 - 13 - 14 mm
- Accoppiamento 1/4" per bit 1/4"



5,5-6-7-8-9-10
11-12-13-14 mm



- 3-4-5-6 mm
- PH1 - 2x PH2 - PH3
- PZ1-PZ2-PZ3
- T10-T15-T20-T25-T27-T30-T40
- 3-4-5-6 mm

LISTINO €75,00
€ 56,00



+ 197 x 90 x 50 mm

Art. 2778

Assortimento "HYPER-BIT box" da 1/4", 138 pezzi



- 6 4-4,5-5,5-6-6,5-8 mm
- 6 2xPH1 - 2xPH2 - 2xPH3
- 6 2xPZ1 - 2xPZ2 - 2xPZ3
- 28 2xT8 - 2xT10 - 2xT15 - 5xT20 - 6xT25 - 3xT27 - 4xT30 - 4xT40
- 16 2xT8 - 2xT10 - 2xT15 - 2xT20 - 2xT25 - 2xT27 - 2xT30 - 2xT40
- 15 TS10 - 2xTS15 - 2xTS20 - 3xTS25 - 2xTS27 - 3xTS30 - 2xTS40
- 5 3-4-5-6-8 mm
- 3 3-4-5 mm
- 3 Nos. 6-8-10
- 3 Nos. 1-2-3
- 4 Nos. 4-6-8-10
- 2 Nos. 1-2
- 3 M5-M6-M8
- 4 Nos. 1-2-3-4

LISTINO €47,00
€ 34,90

DIN 3126
ISO 1173

1/4" 1/4"
C6.3 E6.3



- 3 4-5,5-6,5 mm
- 3 PH 1-2-3
- 3 PZ 1-2-3
- 7 T10-T15-T20-T25-T27-T30-T40
- 2 3-6 mm

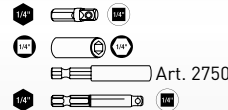

Art. 2750



+ 220 x 150 x 45 mm

Art. 3788

Box di inserti con portainseri magnetico da 1/4", 33 pezzi

- Bit 1/4" da 25 mm: intaglio, Philips, Pozidriv, TORX®, esagonali

LISTINO €25,50
€ 16,00



- 6 4-4,5-5,5-6-6,5-8 mm
- 3 PH 1-2-3
- 6 2x PZ1-PZ2-PZ3
- 12 2x T10-T15-T20-T25-T30-T40
- 4 3-4-5-6 mm



Art. 2765



+ 101 x 56 x 30 mm

Art. 3795

Box di inserti 1/4", 38 pezzi

- Bit 1/4": intaglio, Phillips, Pozidriv, TORX®, esagonali
- Supporto magnetico 1/4" da 60 mm
- Supporto magnetico a cambio rapido 1/4" da 55 mm

LISTINO €44,60
€ 29,00



- 4 4-5,5-6-6,5 mm
- 5 PH0 - PH1 - 2xPH2 - PH3
- 4 PZ1 - 2xPZ2 - PZ3
- T10 - 2xT15 - 2xT20 - 2xT25 - T27 - 2xT30 - T40
- 7 TR10-TR15-TR20-TR25-TR27-TR30-TR40
- 4 3-4-5-6 mm



Art. 3765

Art. 2750



+ 129 x 72 x 35 mm

Art. 11904

Serie di punte HSS-G, Ø 1-10/0.5 mm, 19 pezzi

- Punte HSS per tutti gli usi
- Ø 1,0 mm fino al 10,0 mm con incrementi di 0,5 mm
- DIN 338 tipo N
- Taglio destrorso
- Da Ø 3,0 mm con split point DIN 1412 C
- Angolo punta: 118°
- Angolo elica: 25-30°
- Tolleranza: h8

LISTINO ~~€ 52,00~~
€ 37,00



Art. 11905

Serie di punte HSS-G, Ø 1-13/0.5 mm, 25 pezzi

- Punte HSS per tutti gli usi
- Ø 1,0 mm fino al 13,0 mm con incrementi di 0,5 mm
- DIN 338 tipo N
- Taglio destrorso
- Da Ø 3,0 mm con split point DIN 1412 C
- Angolo punta: 118°
- Angolo elica: 25-30°
- Tolleranza: h8

LISTINO ~~€ 126,00~~
€ 84,00



Art. 13904

Serie di punte HSSE-Co5, Ø 1-10/0.5 mm, 19 pezzi

- Punte HSSE-Co 5 per tutti gli usi
- Ø 1,0 mm fino a 10,0 mm con incrementi di 0,5 mm
- DIN 338 tipo N
- Taglio destrorso
- Da Ø 3,0 mm con split point DIN 1412 C
- Angolo punta: 118°
- Angolo elica: 25-30°
- Tolleranza: h8

LISTINO ~~€ 74,00~~
€ 49,00



Art. 13905

Serie di punte HSSE-Co5, Ø 1-13/0.5 mm, 25 pezzi

- Punte HSSE-G
- Ø 1,0 mm fino a 13,0 mm con incrementi di 0,5 mm
- DIN 338 tipo VA
- Taglio destrorso
- Da Ø 3,0 mm con split point DIN 1412 C
- Angolo punta: 118°
- Angolo elica: 25-30°
- Tolleranza: h8

LISTINO ~~€ 158,00~~
€ 101,00



Art. 3240MOD

Assortimento di maschi a mano ed a macchina, filiere, punte HSS-G ed accessori, 24 pezzi

- Filiera: M3-M12
- Punta elicoidale, HSS, 2.5-3.3-4.2-5.0-6.8-8.5-10.2 mm
- Maschi a mano, M3-M12

LISTINO ~~€ 137,00~~
€ 90,00



Art. 3059

Serie di estrattori di viti, 6 pezzi

- M3-M24
- Per estrarre viti rotte
- Design scanalatura fresata
- Geometria ottimizzata

LISTINO ~~€ 19,80~~
€ 12,50



Art. 2251

Forbici da elettricista

- Lunghezza: 142 mm

LISTINO ~~€ 12,60~~
€ 8,90



Art. 308.330.001

Forbice da elettricista VDE

- Lunghezza 160 mm



1000 V
IEC 60900

LISTINO ~~€ 37,50~~
€ 26,00



Art. 3304

Cutter a serramanico Ergokraft con lama trapezoidale

- Impugnatura ergonomica e antiscivolo in bimateriale
- Meccanismo di sicurezza per lo sgancio rapido della lama
- Blocco/sblocco rapido della lama
- Dispenser con 10 lame trapezoidali di ricambio
- 155 mm

LISTINO ~~€ 10,10~~
€ 7,90

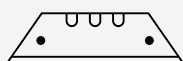

Art. 3310

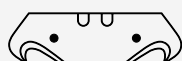

Art. 3303H

Art. 3305

Seghetto

- Telaio leggero con anima in acciaio
- Ideale per lavori manuali
- Manico ergonomico
- Meccanismo di cambio lama veloce
- Per lame da 300 mm ad alte prestazioni

LISTINO ~~€ 27,00~~
€ 18,90



Art. 3312

Cutter universale a lame a settori Ergokraft, 165 mm

- Manico bimateriale con impugnatura ammortizzata
- Con sistema autobloccante
- 6 lame di ricambio da 18 mm

LISTINO ~~€ 8,70~~
€ 5,80



Art. 3323

Coltello a serramanico

- Lama in acciaio Inox
- Corpo in Alluminio
- Lunghezza lama: 76 mm



LISTINO ~~€ 18,60~~
€ 13,50



Art. 4320

Set di lime Ergokraft, 5 pezzi

- Lima piatta, 320 mm (Art. 4320-1)
- Lima mezzatonda, 320 mm (Art. 4320-2)
- Lima tonda, 320 mm (art. 4320-3)
- Lima quadrata, 320 mm (Art. 4320-4)
- Lima triangolare, 320 mm (Art. 4320-5)
- Doppia lama
- Manico ergonomico
- DIN 7261 A-F / ISO R234

LISTINO ~~€ 52,00~~
€ 34,00



Art. 3341

Lente di ingrandimento con luce LED

- Ingrandimento x3 volte
- LED ad alta luminosità con sistema IC integrato che permette di aumentare al massimo la durata della batteria
- Vetro ottico non deformabile di alta qualità
- Manico in bi-materiale

LISTINO ~~€ 22,50~~
€ 16,00



Art. 2970

Calibro corsoio

- In acciaio inossidabile, temprato e rettificato di precisione, con punte a croce
- Nonio e scala cromati opachi
- Con vite di fermo, per misurazioni di profondità fino a 150 mm
- In robusto astuccio di plastica

LISTINO ~~€ 39,00~~
€ 29,90



Art. 2972

Calibro corsoio digitale

- Con vite di fermo, lettura in mm - pollici
- Display LCD a 5 cifre
- Per misurazioni di esterni, interni e di profondità
- In robusto astuccio di plastica

LISTINO ~~€ 53,00~~
€ 39,90



Flessometro

- Extra largo
- Scala graduata doppia in mm
- Gancio grande con 2 magneti
- Robusta cassa in ABS antiurto



Art. n°	Descrizione	Listino	Promo
4706-0319	3 m x 19 mm	€ 12,90	€ 9,50
4706-0527	5 m x 27 mm	€ 20,90	€ 14,90
4706-0827	8 m x 27 mm	€ 28,90	€ 21,50

Morsa parallela da banco

- Morsa in acciaio forgiato
- Base girevole
- Ganascia posteriore con piano ad incudine
- Ganasce indurite intercambiabili



Art. n°	Dimensione	Peso	Listino	Promo
2961	100x120x65 mm	7,5 Kg	€ 162,00	€ 122,00
2962	125x140x70 mm	11 Kg	€ 201,00	€ 155,00
2963	150x170x80 mm	14,5 Kg	€ 242,00	€ 188,00
2964	200x200x90 mm	20,5 Kg	€ 321,00	€ 245,00

Art. 3196

Penna telescopica magnetica

- Testa magnetica Ø 11 mm
- Lunghezza totale: 130 - 640 mm
- Ideale per accedere a luoghi/buchi ciechi e profondi

LISTINO
~~€ 12,70~~
€ 9,50



Art. 3197

Penna telescopica magnetica flessibile

- Testa magnetica Ø 11 mm
- Lunghezza totale: 135 - 570 mm

LISTINO
~~€ 18,70~~
€ 14,50



Art. 3198

Artiglio da presa flessibile con magnete

- Albero flessibile
- Lunghezza totale: 700 mm
- Ideale per accedere a luoghi/buchi ciechi e profondi
- Portata max: 1 Kg

LISTINO
~~€ 30,00~~
€ 21,90



Art. 3360

Assortimento di cacciaspine con impugnatura AirGrip, 5 pezzi

- Forma tonda con estremità passante temprata
- Ø3 x 160 mm, Ø4 x 185 mm, Ø5 x 200 mm, Ø6 x 210 mm, Ø8 x 225 mm
- Possibilità di appendere la confezione al muro

LISTINO
~~€ 81,00~~
€ 62,90



Art. 3359

Bulino automatico

- Manico ergonomico
- Forza di battuta: 8-16 kg
- Punta: Ø 4 mm
- Acciaio al Cromo Vanadio

LISTINO
~~€ 11,60~~
€ 8,90



Martello di tipo tedesco DIN 1041, Hickory

- Modello tedesco
- Testa laccata nera
- Indurito per induzione
- Superfici frontali levigate lucide
- Con cuneo in acciaio e incollaggio epossidico di sicurezza
- Manico in legno duro hickory americano
- DIN 1041



Art. n°	Peso	Listino	Promo
2301	100 g	€ 9,40	€ 7,50
2302	200 g	€ 11,50	€ 7,90
2303	300 g	€ 14,00	€ 9,50
2304	400 g	€ 14,90	€ 10,50
2305	500 g	€ 17,50	€ 12,90
2308	800 g	€ 21,00	€ 14,50
2310	1000 g	€ 25,00	€ 16,90
2315	1500 g	€ 29,00	€ 19,90

Martello di tipo tedesco con manico in fibra di vetro

- Modello tedesco
- Testa laccata nera
- Indurito per induzione
- Superfici frontali levigate lucide
- Con cuneo in acciaio e incollaggio epossidico di sicurezza
- Manico bimatateriale in fibra di vetro
- DIN 1041



Art. n°	Peso	Listino	Promo
2385	300 g	€ 14,50	€ 10,90
2387	500 g	€ 15,50	€ 11,90

Mazzetta con manico in fibra di vetro

- Testa laccata nera
- Indurito per induzione
- Superfici frontali levigate lucide
- Con cuneo in acciaio e incollaggio epossidico di sicurezza
- Manico bimatateriale in fibra di vetro
- DIN 6475



Art. n°	Peso	Listino	Promo
2390	1000 g	€ 23,90	€ 15,50
2392	1250 g	€ 25,00	€ 17,00
2395	1500 g	€ 25,90	€ 18,00

Mazzuola antirimbalzo rivestita in gomma

- Corpo in acciaio
- Graniglia sferica contenuta nella testa della mazzuola per equilibrare la forza d'urto impedendo il rimbalzo
- Battente piatto



Art. n°	Descrizione	Listino	Promo
310.150.001	44 mm, 453 g	€ 27,60	€ 19,90
310.150.002	53 mm, 906 g	€ 38,20	€ 27,90
310.150.003	61 mm, 1359 g	€ 54,50	€ 39,90

Art. 2336

Mazzuola in nylon, 360 g, Hickory

- Inserti PU - Nylon Ø 35 mm
- Con manico sagomato in legno duro Hickory americano e laccato
- Con fissaggio permanente del manico tramite un cuneo in acciaio e resina epossidica



LISTINO ~~€ 25,00~~
€ 17,00

LE PIÙ VENDUTE

Art. 701.001.007

Lampada portatile LED Slimlight 800, ricaricabile

Questa potente e versatile torcia a LED da 800 lumen, con 3 sorgenti luminose, offre l'illuminazione perfetta per ogni situazione. A seconda delle esigenze, può illuminare ampie aree o punti precisi, senza abbagliamento.

- Autonomia 2,5 h - 9 h
- Tempo di ricarica 4 h
- Tensione nominale 100-240 V ~ 50/60Hz
- Batteria Li-Ion 3,7 V 2600 mAh
- Temperatura di esercizio fino a -10°C ~ +40°C
- Temperatura di colore 6500 Kelvin
- LED 7 W COB, 4 W COB, 3 W SMD
- Lumen 120 - 800
- Grado di protezione IP54
- Resistenza agli urti IK07
- Connessione USB-C

Contenuto della confezione

- Cavo USB-C

Accessori

- Caricabatterie con connettore USB-C 5V1A 701.798.002
- Cavo USB-C 1 m art.701.798.003



LISTINO ~~€ 109,00~~
€ 85,00

+ 304 x 29 x 33 mm | Ø 0,2 kg

Art. 703.000.000

Torcia LED a stilo COB 300, ricaricabile

Questa Torcia LED a stilo di alta qualità è sempre a portata di mano grazie al magnete e alla clip per il taschino. La lampada versatile offre due sorgenti luminose, frontale e laterale, che la rendono adatta a una varietà di applicazioni.

- Autonomia 2 h - 5 h
- Tempo di ricarica 2,5 h
- Tensione nominale 100-240 V ~ 50/60Hz
- Batteria Li-Ion 3,7 V / 750 mAh
- Temperatura di esercizio fino a -10°C ~ +40°C
- Temperatura di colore 6500 Kelvin
- Lumen 100 - 300
- LED 3 W COB, 2 W SMD
- Grado di protezione IP20
- Resistenza agli urti IK07
- Connessione USB-C

Contenuto della confezione

- Cavo USB-C

Accessori

- Caricabatterie con connettore USB-C 5V1A art. 701.798.002
- Cavo USB-C 1 m art. 701.798.003

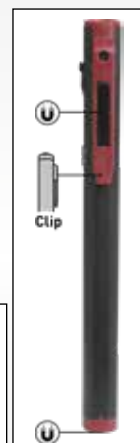

LISTINO ~~€ 43,00~~
€ 33,00

+ 170 x 15 x 21 mm | Ø 0,61 kg

Art. 702.000.000

Lampada da lavoro LED FLEXDOT 600, ricaricabile

- Autonomia 1,5 - 3 h
- Tempo di ricarica 4 h
- Diffusione della luce ad ampio angolo, 100°
- Orientabile a 360°
- Attrezzato con magnete e gancio
- Batteria Li-Ion 3,7 V / 2600 mAh
- 170/330 Lux (1 m)
- 300/600 Lumen
- 6400 Kelvin
- IP65

LISTINO ~~€ 62,00~~
€ 44,00



+ 78 x 76 x 52 mm | Ø 227 g

Art. 702.003.000

Torcia frontale per casco CREE LED H260, ricaricabile

Con sensore di movimento, rotante e rimovibile, dotato di magneti

- 2 - 4h Tempo di funzionamento
- 2,5 h Tempo di ricarica
- Angolo di apertura del fascio di 100°
- Ruotabile a 360°
- Batteria Li-Po 3,7 V / 1400 mAh
- 80/120 lux (1 m)
- 150/260 lumen
- 6400 Kelvin
- IP44

CON SENSORE DI MOVIMENTO



LISTINO ~~€ 57,20~~
€ 42,00

+ 80 x 55 x 45 mm | Ø 0,1 kg

Art. 703.000.001

Torcia LED a stilo SMD 120, ricaricabile

Questa stilo LED SMD 120 ricaricabile è sempre a portata di mano quando ne hai bisogno grazie al magnete integrato e alla clip per il taschino. La lampada versatile offre due sorgenti luminose, frontale e laterale, che la rendono adatta a una varietà di applicazioni.

- Durata di funzionamento 3.5 h - 4.5 h
- Tempo di ricarica 2,5 h
- Tensione nominale 100-240 V ~ 50/60Hz
- Batteria Li-Ion 3,7 V / 750 mAh
- Temperatura di esercizio fino a -10°C ~ +40°C
- Temperatura di colore 6500 Kelvin
- Lumen 100 - 120
- LED 1 W SMD, 2 W SMD
- Grado di protezione IP20
- Resistenza agli urti IK07
- Connessione USB-C

Contenuto della confezione
- Cavo USB-C

Accessori

- Caricabatterie con connettore USB-C 5V1A 701.798.002
- Cavo USB-C 1 m 701.798.003

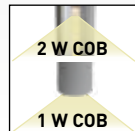
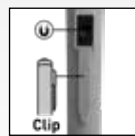

LISTINO
~~€ 33,00~~
€ 22,00

170 x 21 x 26 mm, ∅ 57 g

Art. 701.001.008

Lampada portatile LED Inspection 700, ricaricabile

Questa potente torcia a LED da 700 lumen, grazie al fascio luminoso orientabile di 180°, offre la giusta illuminazione per ogni situazione. Con 3 magneti aggiuntivi e 2 ganci, questa torcia è ideale per lavorare in aree scarsamente illuminate.

- Durata di funzionamento 2 h - 5 h
- Tempo di ricarica 4 h
- Tensione nominale 100-240 V ~ 50/60Hz
- Batteria Li-Ion 3,7 V 2600 mAh
- Temperatura di esercizio fino a -10°C ~ +40°C
- Temperatura di colore 6500 Kelvin
- LED 7 W COB, 4 W SMD
- Lumen 200 - 700
- Grado di protezione IP65
- Resistenza agli urti IK09
- Connessione USB-C

Contenuto della confezione
- Cavo USB-C

Accessori

- Caricabatterie con connettore USB-C 5V1A 701.798.002
- Cavo USB-C 1 m 701.798.003

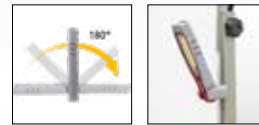

LISTINO
~~€ 104,00~~
€ 65,00

+ 260 x 53 x 39 mm | ∅ 0,4 kg

Art. 701.001.009

Torcia High Power LED 1000, ricaricabile

Dotata di un potente LED da 1000 lumen e di un'autonomia fino a 14 ore, questa torcia è un compagno affidabile in ogni situazione. Il design flessibile a 90° e la robusta classe di protezione IP65 la rendono lo strumento perfetto per il lavoro, le attività all'aperto e le emergenze. La luce bianca fredda a 6000 Kelvin garantisce una visibilità ottimale, mentre la base magnetica integrata assicura un fissaggio sicuro alle superfici metalliche.

- Tempo di ricarica 3 h
- Tempo di funzionamento 3 - 14 h
- Tipo di batteria Li-Ion 3,6V / 2600 mAh
- Lumen 1000
- LED 10 W SMD
- Kelvin 6000
- USB-C
- Magnetico



LISTINO
~~€ 109,00~~
€ 69,00



160 x 30 x 27 mm, ∅ 22 g

Art. 701.001.010

Lampada portatile LED Inspection 400, ricaricabile

La pratica lampada portatile Inspection 400 LED offre una potenza luminosa massima di 400 lumen. È dotata di 1 magnete e 1 gancio girevole e fornisce un'illuminazione ottimale in qualsiasi situazione. La lampada portatile a LED può essere utilizzata sia per applicazioni interne che esterne ed è ideale per l'uso in aree di lavoro scarsamente illuminate.

- Tempo di funzionamento 2,5 h - 6 h
- Tempo di ricarica 2,5 h
- Tensione 100-240 V ~ 50/60Hz
- Batteria Li-Polymer 3,7 V 1500 mAh
- Temperatura d'esercizio da -10°C ~ +40°C
- Temperatura colore 6500 Kelvin
- Potenza LED 4 W COB, 2 W SMD
- Lumen 150 - 400
- Grado di protezione IP IP65
- Grado di resistenza agli urti IK07
- Connessione USB-C

Contenuto della confezione:
- Cavo USB-C

Articoli accessori:

- Caricabatterie con connessione USB-C 5V1A 701.798.002
- Cavo USB-C 1 m 701.798.003



LISTINO
~~€ 55,00~~
€ 35,00



+ 120 x 26 x 61 mm | ∅ 0,15 kg

Art. 701.001.001

Lampada portatile a LED IN.SPOT 400, ricaricabile

2 lati girevoli a 120° e girevoli a 180°, un forte magnete integrato nella base e un gancio girevole e pieghevole nella testa consentono una gamma versatile di applicazioni

- LED 3 W / 1W
- Autonomia 6H (3W) / 10H (1W)
- Tempo di ricarica 3.5 H
- Batteria Li-Ion 3.7 V / 2600 mAh
- Tensione nominale 100-240 V ~ 50/60Hz
- Temperatura di funzionamento -10°C ~ +40°C
- 400 Lumen (3W) 90 Lumen (1W)
- Kelvin 5700 K
- Classe di protezione IP20
- Protezione contro gli urti IK07
- Porta USB-C
- Cavo USB-C

LISTINO ~~€ 69,80~~
€ 48,00



+ 290 x 50 x 90 mm | ⚖ 0,335 kg

Art. 701.001.002

Lampada portatile LED IN.VIEW 500, ricaricabile

2 lati girevoli a 120° e girevoli a 180°, un forte magnete integrato nella base e un gancio girevole e pieghevole nella testa consentono una gamma versatile di applicazioni.

- LED 3 W COB LED / 1W SMD LED
- Autonomia 3.5 h (3W) / 10 h (1W)
- Tempo di ricarica 4 h
- Batteria Li-Ion 3.7 V / 2600 mAh
- Tensione nominale 100-240 V ~ 50/60Hz
- Kelvin 5700K
- Lumen 500 (3W) / 70 (1W)
- Temperatura di funzionamento -10°C ~ +40°C
- Classe di protezione IP20
- Protezione contro gli urti IK07
- Porta USB-C
- Cavo USB-C

LISTINO ~~€ 79,90~~
€ 55,00



+ 290 x 49 x 66 mm | ⚖ 0,335 kg

Art. 701.001.003

Lampada portatile a LED IN.VIEW.SLIM 500, ricaricabile

Design robusto e resistente agli urti con alloggiamento della testa in alluminio che può essere ruotato di 180°. Per un'ampia gamma di applicazioni, la base è dotata di un forte magnete e la testa è dotata di un ulteriore gancio pieghevole.

- LED 4.5 W COB, 1 W SMD
- Autonomia 3.5 H (4.5W) / 10 H (1W)
- Tempo di ricarica 4 H
- LED COB da 4,5 W nella parte anteriore
- LED SMD da 1 W nel corpo lampada
- Batteria Li-Ion 3.7 V / 2600 mAh
- Tensione nominale 100-240 V ~ 50/60Hz
- Lumen 500 (4.5W) / 80 (1W)
- Kelvin 5700 K
- Temperatura di funzionamento -10°C ~ +40°C
- Classe di protezione IP20
- Protezione contro gli urti IK07
- Porta USB-C
- Cavo USB-C

LISTINO ~~€ 99,00~~
€ 78,00

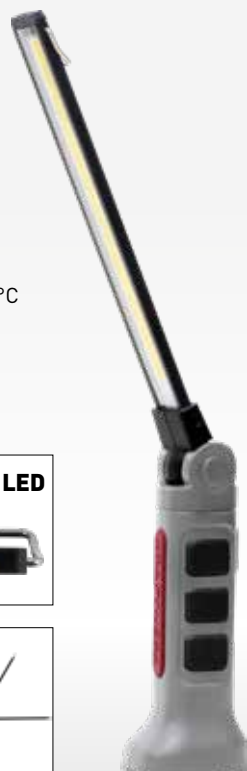
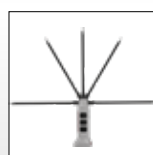

+ 358 x 56 x 43 mm | ⚖ 0,31 kg

Art. 701.001.004

Torcia ricaricabile LED Compact 250

- Autonomia 3 h
- Tempo di ricarica 3.5 h
- Con magnete sul retro e gancio incorporato
- Batteria Li-Ion 3.7 V / 1500 mAh
- 870 Lux (0.6 m)
- 250 lumen
- 5700 Kelvin
- IP65
- IK07

Articolo accessorio:

- 701.798.001 Caricatore con connessione USB-C
- 701.798.003 Cavo USB-C 1 m

LISTINO ~~€ 64,50~~
€ 50,00

+ 212 x 34 x 57 mm | ⚖ 0,34 kg



Art. 701.001.006

Lampada portatile LED Slimlight 700 con funzione dimmer

Questa torcia a LED, potente e dimmerabile, da 700 lumen, grazie al fascio luminoso orientabile di 180°, offre l'illuminazione giusta per ogni situazione. Un potente magnete e un gancio pieghevole consentono di adattare individualmente l'area di applicazione. Luce principale COB da 7 W per un'illuminazione potente. Luce supplementare SMD da 3 W per un'illuminazione dettagliata priva di abbagliamento.

- Autonomia 2 h - 16 h
- Tempo di ricarica 4 h
- Tensione nominale 100-240 V ~ 50/60Hz
- Batteria Li-Ion 3,7 V 2600 mAh
- Temperatura di esercizio fino a -10°C ~ +40°C
- Temperatura di colore 6500 Kelvin
- LED 7 W COB, 3 W SMD
- Lumen 70 - 700
- Classe di protezione IP54
- Resistenza agli urti IK07
- Connessione USB-C

Contenuto della confezione

- Cavo USB-C

Accessori

- Caricabatterie con connettore USB-C 5V1A 701.798.002
- Cavo USB-C 1 m 701.798.003

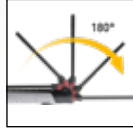
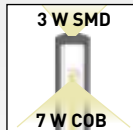

LISTINO ~~€ 94,00~~
€ 70,00



+ 397 x 66 x 46 mm | ⚖ 373 g

Art. 32069

Lampada portatile LED COB COMPACT MINI 180, ricaricabile

- 3 ulteriori LED posti nella testa lampada, sostegno magnetico orientabile a 270° su ambo i lati, ulteriore magnete sul retro
- Autonomia 2-15 h
- Tempo di ricarica 2 h
- Batteria Li-Ion 3,7 V / 800 mAh
- 110 Lux (1 m)
- 15/180 lumen
- IP54
- Fornita con cavo USB

Accessori

- Caricabatteria 230 V art. 32070AL
- Adattatore per auto 12 / 24 V art. 32070DL

LISTINO ~~€ 32,00~~
€ 24,50



+ 178 x 43 x 35 mm | ⚖ 0,23 kg

Art. 702.001.000

Lampada da lavoro compatta T1000, ricaricabile

Compatta, ricaricabile con attacco USB Type-C

- Autonomia 2,5 - 6 h
- 4 h Tempo di ricarica
- Angolo del fascio di 100°
- 210° ruotabile
- Batteria Li-Ion 3,7 V / 4000 mAh
- 360 lux (1 m)
- 1000 Lumen
- 6000 Kelvin
- IP65
- IK08



LISTINO ~~€ 86,00~~
€ 65,00



+ 175 x 135 x 45 mm | ⚖ 0,4 kg

Art. 32061

Torcia frontale per casco CREE LED

- Autonomia 4 - 12 h
- In alluminio, con LED CREE 3 watt
- Funzione dimmer, zoom e lampeggiante
- Angolo di illuminazione regolabile in continuo
- 4 - 12 h running time
- 160 Lumen
- IP44

Accessori

- Batterie AAA (3x) art. 32013

LISTINO ~~€ 32,90~~
€ 23,00



+ 45 mm Ø 40 mm | ⚖ 0,13 kg

Art. 32037

Lampada da lavoro LED HEXA 2000, ricaricabile

- Autonomia 2,5 - 10 h
- 3 livelli di luminosità: 25/50/100%
- Tempo di ricarica 3,5 h
- 20 W
- Batteria Li-Ion 11,1 V / 4400 mAh
- 500/1000/2000 lumen
- 6000 Kelvin
- IP65
- IK07
- Fornita con caricabatteria 230 V (art. 32037AL)



LISTINO ~~€ 195,00~~
€ 144,00

+ 225 x 220 x 77 mm | ⚖ 1,4 kg

Art. 32080

Lampada da lavoro LED T5000

- 2 prese SCHUKO sul retro, presa europea
- Scocca in plastica robusta e resistente agli urti, con protezione degli angoli
- 47 Watt
- 120 SMD LED
- 1860 Lux (1 m)
- 5000 Lumen
- 6000 Kelvin
- IP54
- Cavo di 5 m
- 230 VAC tensione di esercizio



LISTINO ~~€ 189,00~~
€ 142,00

47 WATT

+ 363 x 278 x 98 mm | ⚖ 2,7 Kg

Art. 32081C

Lampada da lavoro LED T2500 con cavalletto telescopico estraibile

- Struttura a 3 gambe metalliche per un buon equilibrio
- La lampada ruota di 360°
- Estendibile da 69 a 165 cm
- Presa europea



LISTINO ~~€ 159,00~~
€ 119,00

Art. 32078

Lampada da lavoro LED W1000, ricaricabile

- Autonomia 4 h
- Tempo di ricarica 4 h
- 10W COB LED
- Batteria Li-Ion 7,4 V / 2200 mAh
- 400 - 1000 Lumen
- 6400 Kelvin
- IP65
- Fornita con Caricabatteria 230 V art. 32070AL
- Adattatore per auto 12 / 24 V art. 32070DL

RICARICABILE

Accessori

- Asta telescopica art. 32078-01
- Supporto art. 32078-02

LISTINO ~~€ 121,00~~
€ 94,00



+ 172 x 55 x 150 mm | ⚖ 0,72 kg

Art. 702.004.000

Lampada a LED estensibile per illuminare il vano motore, 20 W / 50 SMD

Questa lampada LED per vano motore, estraibile e girevole a 360°, offre una luce intensa e uniforme, ideale per l'ispezione di motori, impianti elettrici e altri componenti nel vano motore.

- Durata di funzionamento 2 h - 6,5 h
- Tempo di ricarica 4,5 h
- Tensione nominale 100-240 V ~ 50/60Hz
- Batteria Li-Ion 3,65 V 5000 mAh
- Temperatura di esercizio fino a -10°C ~ +40°C
- Temperatura di colore 5700 Kelvin
- LED 20 W / 50 SMD
- Lumen 500 - 2000
- Grado di protezione IP20
- Resistenza agli urti IK07
- Connessione USB-C

Contenuto della confezione

- Cavo USB-C, ricaricabile

Accessori

- Caricabatterie con connettore USB-C 5V1A 701.798.002
- Cavo USB-C 1 m 701.798.003
- Li-Ion Batterie 5000 mAh 701.798.005

LISTINO ~~€ 149,00~~
€ 120,00



**NUOVO
 PRODOTTO**

360°

+ 1170 min. - 1970 max. x 110 x 180 mm | ⚖ 1110 g

Art. 31311

Caricabatterie

- Voltaggio batteria: 6-12 V
- Consumo d'energia: 30 W
- Voltaggio operativo:
6V: 2,2 - 14 Ah
12V: 2,2 - 40 Ah
- Ricarica ad impulsi: ✓
- Corrente di ricarica: max. 1,1 A
- Corrente in entrata: 220 - 240 V / 0,35 A
- Adatto per: SLA, AGM, WET, GEL, MF, Ca-Ca

LISTINO ~~€ 79,00~~
€ 60,00

6/12 VOLT



+ 153,5 x 59 x 37,5 mm

Art. 31312

Caricabatterie

- Voltaggio batteria: 12 V
- Consumo d'energia: 60 W
- Voltaggio operativo:
12 V: 1,2 - 120Ah
- Ricarica ad impulsi: ✓
- Corrente di ricarica: max. 3,8 A
- Corrente in entrata: 220 - 240 V / 0,6 A
- Adatto per: SLA, AGM, WET, GEL, MF, Ca-Ca

LISTINO ~~€ 105,00~~
€ 84,00

12 VOLT



+ 175 x 65 x 43,5 mm

Art. 31314

Caricabatterie

- Voltaggio batteria: 12-24 V
- Consumo d'energia: 460 W
- Voltaggio operativo:
12 V: 50 - 450 Ah
24 V: 25 - 230 Ah
- Ricarica ad impulsi: ✓
- Corrente di ricarica: max. 25 A
- Corrente in entrata: 220 - 240 V / 4 A
- Adatto per: SLA, AGM, WET, GEL, MF, Ca-Ca

LISTINO ~~€ 440,00~~
€ 329,00

12/24 VOLT



+ 305 x 135 x 70 mm

Art. 506.000.100

Avviatore di emergenza + Powerbank, 12V, 500CA - 1000PA, 55,5 Wh

- Indica istantaneamente il livello della batteria
- Design compatto con finitura soft-touch
- Ideale per motori fino a 10 cilindri
- Tecnologia Qualcomm® Quick Charge™ in grado di caricare 4x più rapido
- Porta USB tipo C utilizzabile sia come input sia come output
- Cavo intelligente fornisce protezione contro diverse fonti di errore
- Lampada a LED integrata con 3 modalità
- Con custodia da viaggio
- Batteria: Polimeri di Litio 55,5 Wh
- Durata batteria: 1000 cicli
- Corrente di avviamento: 500CA - 1000PA
- Temperatura di utilizzo: -20°C a 60°C / -4°F a 140°F
- USB ingresso: 5V DC, 2A MICRO-USB, 15W, 3A USB tipo C
- USB uscita: 5V DC, 2.4A + Qualcomm® Quick Charge™: 3.0 15W, 3A USB tipo C



LISTINO ~~€ 265,00~~
€ 205,00



Gamma Booster KRAFTWERK



Art. 31305
ΔΔ 11,70 kg

12 V



Art. 31306
ΔΔ 11,70 kg

12 V - 24V



Art. 31307
ΔΔ 11,70 kg

12 V - 24V



Tecnologia	Batteria / Acido	Batteria / Acido	Batteria / Acido
Cliente	Garage	Garage	Garage
Prezzo di listino	€ 525,00	€ 1.139,00	€ 1.329,00
Prezzo Promo	€ 370,00	€ 839,00	€ 990,00

Caratteristiche del prodotto			
VOLT	12	12 - 24	12 - 24
Corrente di picco	2.500 A	5.000 / 2.500 A	6.200 / 3.100 A
Batteria piombo/calcio	1	2	2
Condensatori Farad	-	-	-
Durata in cicli	500	500	500
Protezione dalle sovratensioni	✓	✓	✓
Allarme di polarità inversa (Visibile e udibile)	✓	✓	✓
Interruttore ON/OFF	✓	✓	✓
Fusibile	✓	✓	✓
Scocca in ABS	✓	✓	✓
Caricatore automatico	✓	✓	✓
Presa accendisigari + cavo	✓	✓	✓
Clip intercambiabili in ottone massiccio	✓	✓	✓
Sezione cavo	35 mm ²	50 mm ²	35 mm ²
Lunghezza del cavo	155 cm	235 cm	206 cm

DURATA DI VITA: 500 CICLI

Art. 31320

Δ 15,82 kg

12V - 24V



Art. 403.015.020

Δ 11,50 kg

12V



Condensatore	Condensatore + Batteria / Acido	Tecnologia
Autosoccorso	Tutto il mercato	Cliente
€ 2.150,00	€ 750,00	Prezzo di listino
€ 1.659,00	€ 595,00	Prezzo Promo

		Vantaggi per il cliente
12 - 24	12	1 Lavoro 1 Booster adeguato
20.000 / 10.000 A	3.800 / 1.800 A	
-	1	Alta qualità dell'alimentazione che supporta cicli intensivi di carica e scarica
10 x 600 Farad	5 x 190 Farad	
1.000.000	1.000.000 Condensatore, 500 Batteria	Protezione dei veicoli
✓	✓	
✓	✓	Evita di danneggiare il dispositivo se la polarità è invertita
✓	✓	Preserva la batteria dalla scarica in modalità off
✓	✓	La tranquillità di sapere che né il Booster, né il veicolo siano danneggiati
✓	✓	Praticamente indistruttibile in caso di caduta
✓	✓	Spegnimento automatico al 100% della ricarica
✓	✓	Può essere ricaricato sul veicolo
✓	✓	Forza, tensione e contatto ottimale con le pinze
35 mm ²	35 mm ²	Sezione trasversale molto grande per la massima potenza
210 cm	175 cm	Utilizzo del booster dal suolo

IL PIÙ VENDUTO

Art. 3989

Letto per riparazioni sotto vettura e sgabello 2 in 1

- Telaio in alluminio
- Seduta rivestita in gomma



+ 540 x 455 x 500 mm

Max.
150
kg



+ 1020 x 455 x 150 mm

LISTINO ~~€ 119,00~~
€ 93,00

Art. 3988

Letto sottovettura De Luxe

- Pratico letto per lavorare comodamente sotto l'automobile
- 6 ruote orientabili
- Comodo materassino in gommapiuma e poggiatesta imbottito
- Portata massima 180 Kg

LISTINO ~~€ 129,00~~
€ 79,00



+ 1135 x 510 x 185 mm

Art. 3991

Letto per riparazioni sottovettura in plastica ABS

- Costruito in solido ABS dotato di un pratico manico di trasporto
- Con forma ergonomica per un adattamento facile a tutte le fisionomie permettendo un facile movimento di braccia e spalle
- Dotato di un comodo appoggiatesta imbottito
- Portautensili sagomati nella struttura su entrambi i lati
- 6 ruote gommate su cuscinetti indipendenti

max.
120
kg ABS

LISTINO ~~€ 88,00~~
€ 59,00



+ 1010 x 480 x 115 mm

Art. 3984

Seggiolino da officina

- Con 5 ruote girevoli
- Comoda imbottitura
- Base porta-attrezzi

Max.
135
kg

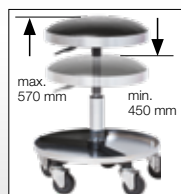

max.
570 mm
min.
450 mm



+ 450 - 570 mm, Ø 450 mm

LISTINO ~~€ 132,00~~
€ 96,00

Art. 38110

Sollevatore idraulico a carrello, 2 T

- Design compatto e ribassato
- Altezza di sollevamento da 85 a 380 mm

LISTINO ~~€ 105,00~~
€ 84,00



♁ 13 kg

Art. 38112

Sollevatore idraulico 2 T

- Robusto telaio in alluminio
- Forma ribassata
- Altezza di sollevamento da 75 a 505 mm

LISTINO ~~€ 325,00~~
€ 249,00



♁ 32 kg

Art. 3981-NE

Sollevatore idraulico ribassato, 2 T

- Struttura allungata, dotato di 6 ruote
- Altezza sollevamento da 76 a 510 mm
- Pedale di sollevamento rapido

LISTINO ~~€ 459,00~~
€ 355,00



♁ 26,4 kg

Art. 38101

Sollevatore idraulico, 3 T

- Altezza di sollevamento da 145 a 500 mm
- Sollevamento rapido con pedale

LISTINO ~~€ 310,00~~
€ 239,00



♁ 38 kg

Art. 38114

Sollevatore idro-pneumatico

- Ideale per autobus, camion e officine di riparazione auto
- Design robusto e stabile, con grandi ruote
- Veloce e facile sollevamento/abbassamento
- Inclusi 4 adattatori
- Capacità: 22 t
- Pressione di esercizio: 7-8 bar
- Distanza minima dal suolo: 215 mm
- Ram sollevamento: 110 mm
- Altezza massima di sollevamento: 430 mm
- Peso netto: 45 Kg
- Pressione dell'aria: 0.7/1.0 Mpa



+ 552 x 316 x 251 mm

22 T



LISTINO ~~€ 670,00~~
€ 535,00

Art. 3979

Coppia di cavalletti 3 T

- Altezza 280-420 mm

LISTINO
~~€ 69,00~~
€ 50,00



± 7 Kg

Martinetto idraulico

- Valvola di sicurezza contro il sovraccarico
- Pistone telescopico
- Impugnatura in 2 pezzi
- Elevata stabilità

Art. n°	Cap.	Min. mm	H1 mm	H2 mm	Max. mm	kg	Listino	Promo
3975	2 T	181	116	48	345	2.6	€ 32,90	€ 25,00
3976	6 T	216	127	70	413	4.5	€ 47,70	€ 38,00
3977	12 T	230	155	80	465	7.3	€ 81,00	€ 60,00
3978	20 T	242	150	60	452	11	€ 108,00	€ 80,00



Art. 3834

Avvitatore a percussione ultra compatto 1/2"

- Avvitatore a doppia massa
- Coppia max. 744 Nm
- 3-livelli di intensità
- Cassa in alluminio
- Design compatto e leggero, 1,6 kg
- Selezione des/sin ad una mano
- Uscita aria nell'impugnatura

744 Nm

± 1,6 kg



LISTINO
~~€ 222,00~~
€ 169,00

Art. 3083

Serie di chiavi a bussola rivestite a macchina 1/2", tipo lungo, 4 pezzi

- Misure: 17 - 19 - 21 mm
- Giunto
- Molto robuste
- Per utensili elettrici e pneumatici standard
- Le protezioni in plastica prevengono danni ai cerchi
- DIN 3121 | ISO 1174
- Acciaio al Cromo Molibdeno

LISTINO
~~€ 52,00~~
€ 35,00



Art. 3057

Serie estrattori per viti rotte 3/8"+1/2", 11 pezzi

- Misure 3/8": M2 - M7
- Misure 1/2": M8 - M16
- Profilo aggressivo
- Per allentare viti e dadi danneggiati
- DIN 3121 | ISO 1174
- Acciaio al Cromo Molibdeno

LISTINO
~~€ 109,00~~
€ 85,00



Art. 3086

Serie di chiavi a bussola esagonali a macchina 1/2", 12 pezzi

- Versione lunga
- Per utensili elettrici e pneumatici standard
- DIN 3121 | ISO 1174
- Acciaio al Cromo Molibdeno

LISTINO
~~€ 133,00~~
€ 98,00



+ 210 x 145 x 50 mm

Art. 3084

Serie di chiavi maschio a macchina Torx 1/2", 12 pezzi

- Versione lunga
- Per utensili elettrici e pneumatici standard
- DIN 3121 | ISO 1174
- Acciaio al Cromo Molibdeno

LISTINO
~~€ 127,00~~
€ 89,00



+ 210 x 145 x 50 mm



Art. 31030

Pistola di soffiaggio ad aria compressa

- Per soffiare e pulire grazie ad un flusso d'aria controllato
- Con filettatura di connessione 1/4" BSP
- Flusso massimo 132 l / min.
- Pressione di ingresso 14 bar
- Livello di pressione sonora 75 dBA



LISTINO ~~€ 15,80~~
€ 12,00

Art. 31032

Pistola di soffiaggio ad aria compressa

- Con beccuccio ad alta potenza e incremento progressivo dell'aria
- Con filettatura di connessione 1/4" BSP
- Flusso massimo 467 l / min.
- Pressione di ingresso 14 bar
- Livello di pressione sonora 85 dBA



LISTINO ~~€ 20,10~~
€ 14,00

Art. 31033

Mini pistola di soffiaggio ad aria compressa

- Per soffiare e pulire grazie ad un flusso d'aria controllato
- Con filettatura di connessione 1/4" BSP
- Flusso massimo 184 l / min.
- Pressione di ingresso 8 bar
- Livello di pressione sonora 88 dBA



LISTINO ~~€ 21,10~~
€ 14,90

Art. 31041

Tubo pneumatico con avvolgitore automatico, 15 + 1 m

- Struttura girevole fino a 180°, con sistema di arresto automatico
- Riavvolgitura frenata del tubo
- Struttura in PP
- Tubo rinforzato in polimeri
- Diametro interno 9.5 mm / Diametro esterno 14.5 mm, attacco 1/4"
- Pressione di utilizzo 18 bar
- Temperatura: -5°C to 45°C
- Con montaggio a parete



LISTINO ~~€ 185,00~~
€ 139,00

Art. 31003

Manometro professionale analogico

- Con largo display fino a 12 bar e 174 psi
- Rubber coated housing
- Incluso un connettore da 1/4"



LISTINO ~~€ 92,00~~
€ 59,00

Art. 31004

Manometro professionale digitale

- Manometro con display digitale retroilluminato
- Misurazioni in bar, psi, kpa e kgf
- Ideale per la regolazione e controllo della pressione
- Rivestito in gomma
- Incluso un connettore da 1/4"



LISTINO ~~€ 119,00~~
€ 72,00

Estrattore universale 4 in 1

- Estrazione esterna o interna
- Estrattore intercambiabile a 2 o 3 griffe



4 IN 1



Art. n°	C min. mm	C max. mm	H mm	mm	Listino	Promo
4971-4	76	102	190	17	€ 119,00	€ 79,00
4971-7	76	178	270	19	€ 233,00	€ 155,00

Art. 30652

Chiave a spirale per filtro dell'olio, 3/8" + 1/2"

- 3 bracci
- Adattatore per chiavi a bussola incluso, 21 mm
- Regolazione del lato sinistro e destro
- Rilascio e serraggio di diverse dimensioni
- Installazione e rimozione di filtri e cartucce filtro



LISTINO ~~€ 30,80~~
€ 21,00

Chiave a nastro per filtro olio con meccanismo a cricchetto

- Per filtri dell'olio, generatori e altre connessioni rotonde
- Operazione a una mano
- Per luoghi difficili da raggiungere
- Regolazione ruotando la manopola
- Manico ergonomico

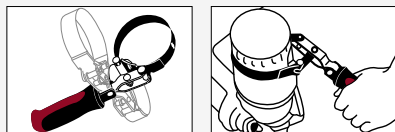

Art. n°	Diametro	Listino	Promo
30616-076	60-76 mm	€ 28,70	€ 19,50
30616-085	73-85 mm	€ 28,70	€ 19,50
30616-099	85-99 mm	€ 29,70	€ 20,00
30616-111	95-111 mm	€ 29,70	€ 20,00

Chiave a nastro metallico per filtro olio

- Per filtri dell'olio, generatori e altre connessioni rotonde
- Operazione a una mano
- Per luoghi difficili da raggiungere
- Regolazione ruotando la manopola



Art. n°	Diametro	Listino	Promo
30617	65-110 mm	€ 10,50	€ 7,90
30618	110-155 mm	€ 12,50	€ 9,50

Art. 31126

Verificatore OBD-II

- Strumento di diagnostica per auto
- Per tutti i veicoli costruiti dopo il 1996 con porta OBD-II
- Permette la lettura e la cancellazione di codici errore
- Supporta i protocolli CAN, VPW, PMW, ISO e KWP 2000

LISTINO ~~€ 105,00~~
€ 75,00



Art. 31130

Multimetro digitale

- CAT III 600 V
- Misurazione voltaggio DC/AC da 0.4 - 600 V
- Intervallo di misurazione della corrente DC/AC 10 A
- Più di 10 funzioni
- Display illuminato
- Temperatura di utilizzo -55°C ~ 1'000°C

LISTINO ~~€ 116,00~~
€ 79,00



CAT. II 1000 V CAT. III 600 V

+ 178 x 85 x 40 mm

Art. 505.001.001

Pinza amperometrica 1000A

- Lunghezza del cavo: 1 m
- Misurazione della tensione
- Misurazione di corrente
- Test diodi
- Misurazione di continuità
- Modilità Data Hold
- Apertura delle ganasce: 55 mm
- Tensione DC: 600 V ± (0.5%+5)
- Tensione AC: 600 V ± (1%+5)
- Corrente DC: 200/1000 A ± (2.5%+5)
- Corrente AC: 200/1000 A ± (2.5%+5)
- Resistenza: 200 Ohm ± (1.2%+5)
- Frequenza: 2 kHz ± (2%+5)
- Alimentatore: 9 V x1
- IEC-6101010 CATII con protezione di sovratensione
- Schermo digitale LCD 16 mm a 3 cifre
- Scala automatica
- Batterie e cavi inclusi

LISTINO ~~€ 199,00~~
€ 139,00



+ 250 x 100 x 46 mm | 365 g

Art. 505.003.001

Termometro digitale a raggi infrarossi

- Campo di misura: da -40°C a 580°C/
da -40°F a 1076°F
- Commutazione: °C/°F
- Display LCD con retroilluminazione
- Funzione Data Hold
- Spegnimento automatico
- Laser Classe II
- Batteria da 9V (6F22/6LR61)

LISTINO ~~€ 125,00~~
€ 99,00



Art. 3912

Carrello da trasporto a ripiani per multiuso

- Costruzione solida per uso universale con 3 grandi ripiani
- Dimensioni esterne 910 x 480 x 140 mm
- Larghezza/profondità ripiano 660 x 390 mm
- Portata ripiano max. 80 kg
- Portata max. 240 kg
- 4 ruote girevoli, Ø 100 mm, di cui 2 con freni

LISTINO ~~€ 303,00~~
€ 234,00



Art. 3985

Piattaforma da lavoro in alluminio

- Altezza di 480 mm
- Portata massima 200 Kg



LISTINO ~~€ 153,00~~
€ 99,00



Art. 401.015.050

Sollevatore idraulico da fossa 0.5 t

Il sollevatore per cambi con una capacità di carico massima di 500 kg è uno strumento indispensabile per ogni officina. Consente di sollevare e abbassare in modo sicuro e preciso le scatole del cambio e altri carichi pesanti. Con un'altezza minima di 1140 mm e un'altezza massima di 1950 mm, questo martinetto per cambi offre un'ampia altezza di sollevamento che garantisce un'ampia gamma di applicazioni. Il suo design robusto e la sua maneggevolezza lo rendono ideale per i meccanici professionisti e gli hobbisti più ambiziosi.

LISTINO ~~€ 289,00~~
€ 227,00



Art. 38131

Supporto mobile per il montaggio del motore

Per tutti gli interventi di manutenzione su tutti i motori e le scatole del cambio

- Ampia gamma di opzioni di regolazione e montaggio
- Ruotabile a 360° e bloccabile in 8 posizioni per lavorare su ogni lato del motore/cambio
- Fissaggio con perno di sicurezza
- Quando non è in uso, è sufficiente ripiegare i piedini = minimo ingombro
- 5 ruote: 3 girevoli, due con freno
- Prese d'aria sulla piastra di adattamento: Ø 13 mm
- Piastra adattatore: girevole a 360 (larghezza massima di montaggio: 39,5 cm / altezza massima di montaggio: 28,6 cm)
- Altezza dal pavimento all'asse della piastra di montaggio: 86,2 cm
- Dimensioni in fase di allestimento (LxPxA): 810 x 825 x 875 mm
- Dimensioni piedi ripiegati (LxPxA): 375 x 825 x 875 mm
- Capacità di carico: 680 kg
- Peso netto: 33 kg



LISTINO ~~€ 242,00~~
€ 185,00



Art. 401.010.001

Gru da officina pieghevole 1 t

- Valvola di sgancio rapido
- Speciale altezza di marcia ridotta
- Ruote in acciaio
- Capacità di carico massima: 1000 kg
- Lunghezza braccio di sollevamento: 900 - 1170 mm
- Altezza minima di sollevamento: 25 mm
- Altezza massima di sollevamento: 1900 mm
- Dimensioni da ripiegato (LxLxA): 1515 x 980 x 1375 mm
- Dimensioni ripiegato (LxLxH): 670 x 620 x 1540 mm
- Dimensioni braccio di estensione al cilindro: 597 - 1046 mm
- Altezza del carrello: 110 mm
- Ø Ruote: 89 mm
- Peso netto: 65 kg

LISTINO ~~€ 459,00~~
€ 349,00



MOBILIO BLACK



Accedi ora al configuratore online per personalizzare la tua officina secondo le tue esigenze.

Scopri di più e configura ora:
mobilio-configurator.kraftwerktools.com

